



Joists 101

Steel Joists and Joist Girders

SEPTEMBER 19, 2018

Copyright © 2018 Steel Joist Institute. All Rights Reserved.

Bruce F Brothersen, PE Engineering Manager, Vulcraft
Tim Holtermann, P.E., S.E., Engineering Manager, Canam

Polling Question

- New requirement to earn PDH credits
- Two questions will be asked during the duration of today's presentation
- The question will appear within the polling section of your GoToWebinar Control Panel to respond

Disclaimer

The information presented herein is designed to be used by licensed professional engineers and architects who are competent to make a professional assessment of its accuracy, suitability and applicability. The information presented herein has been developed by the Steel Joist Institute and is produced in accordance with recognized engineering principles. The SJI and its committees have made a concerted effort to present accurate, reliable, and useful information on the design of steel joists and Joist Girders. The presentation of the material contained herein is not intended as a representation or warranty on the part of the Steel Joist Institute. Any person making use of this information does so at one's own risk and assumes all liability arising from such use.

Learning Objectives

- Introduction to Open Web Steel Joists and Joist Girders
- Explain uses for Steel Joists and Joist Girders.
- Current SJI specifications and their use in designing structures for supporting Steel Joists and Joist Girders.
- How to specify a Steel Joist and Joist Girder.

Steel Joists and Joist Girders

- **Introduction to Open-Web Steel Joists**
- **Current Usage**
- **Specification of Components**





Steel Joist Institute

Background and Development

- The Steel Joist Institute was founded in 1928 and produced its first Catalog and Specifications in 1932.
- The SJI's 44th edition catalog contains the most current information for Joists and Joist Girders

SJI

- The SJI current catalog is the 44th edition.
- The catalog includes SJI 100-2015, the Standard Specifications for **K-Series**, **LH-Series**, and **DLH-Series** Open Web Steel Joists and for Joist Girder.



THE 44TH EDITION

K-Series | LH-Series | DLH-Series | Joist Girders

STANDARD SPECIFICATIONS

Load Tables and Weight Tables for Steel Joists and Joist Girders

SJI 100-2015 | American National Standard

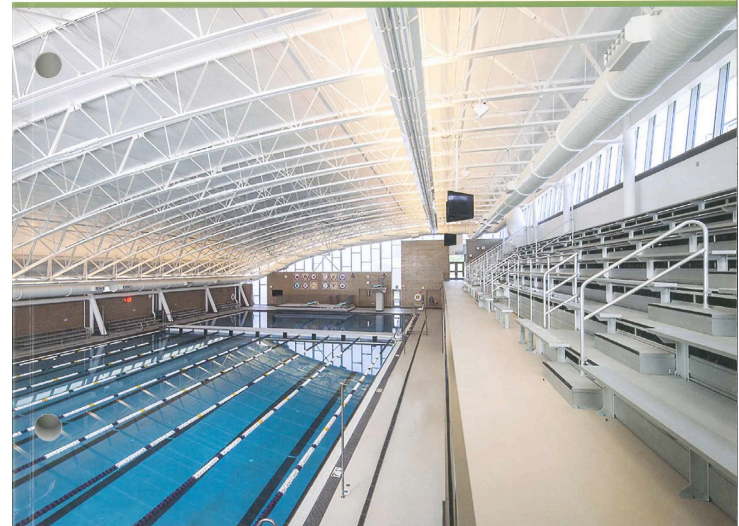

Glossary of Terms

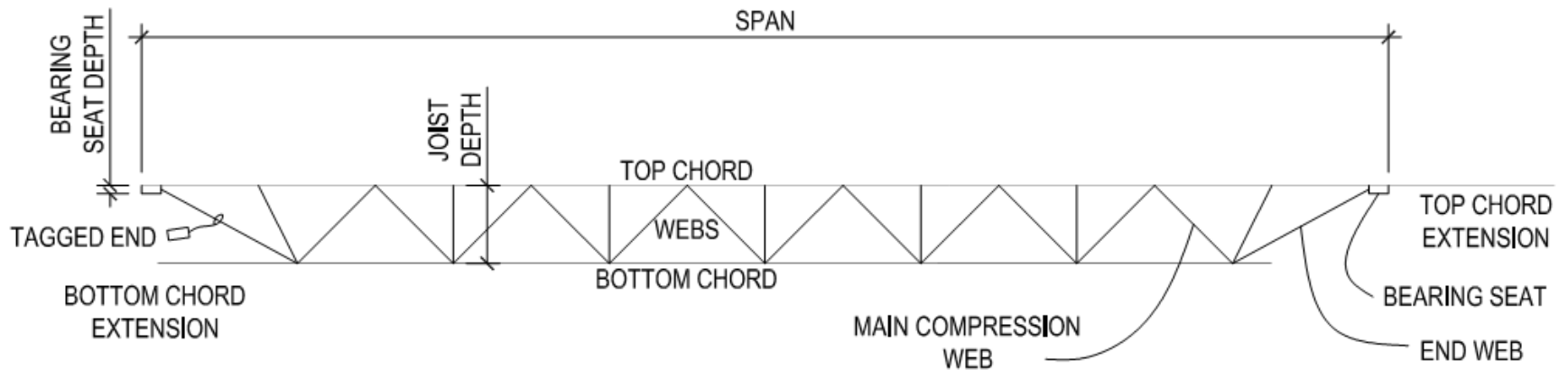

Glossary of Terms

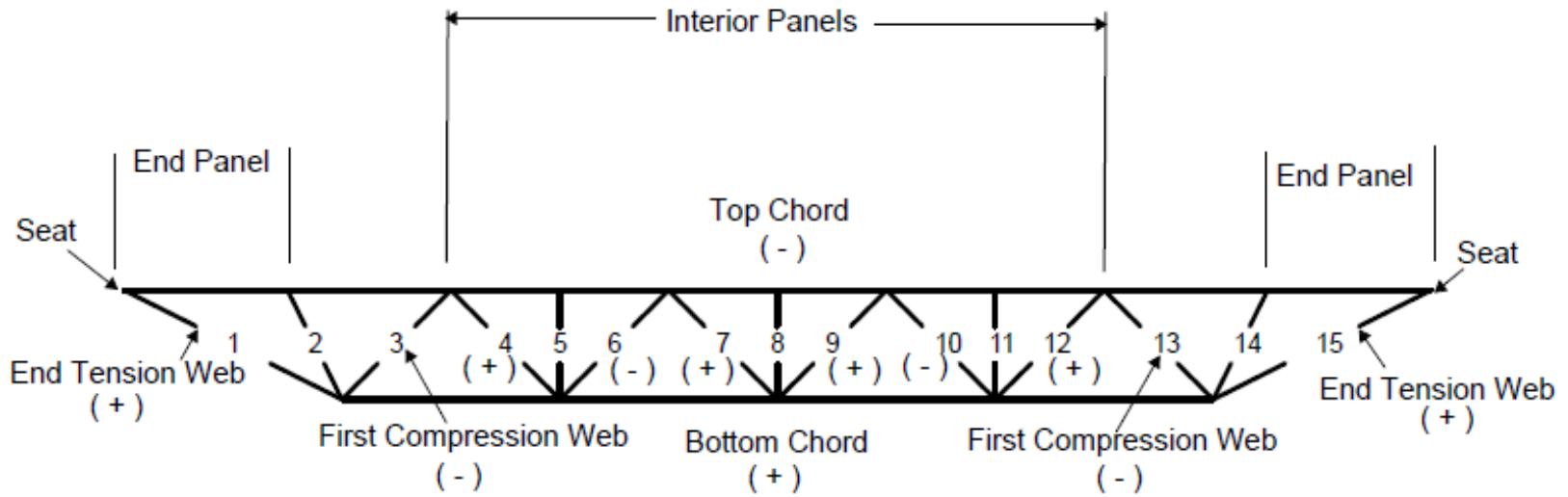

(+) tension

(-) compression

Joist Basics



Joist Basics

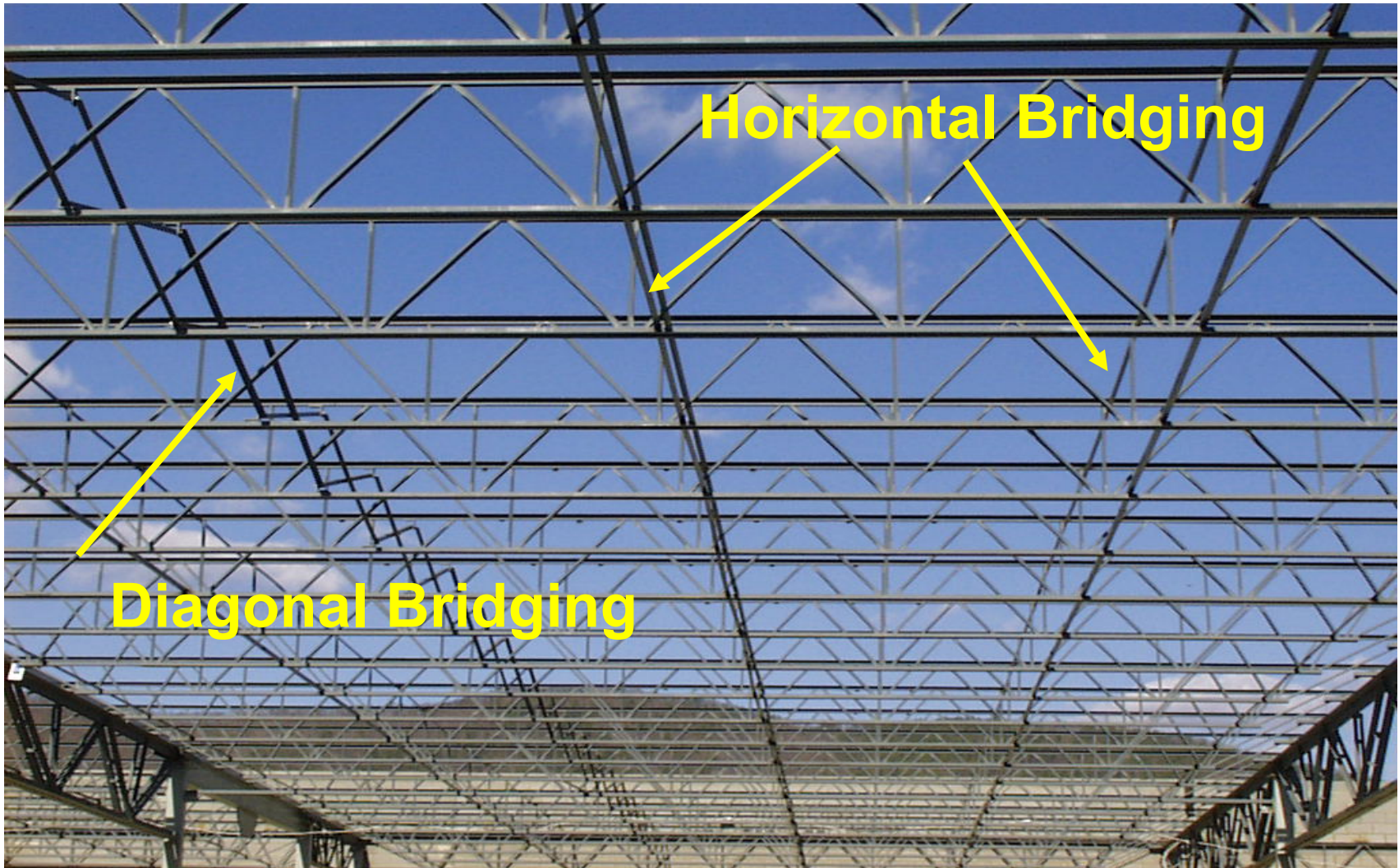

Joist History 1930's



Joist History 1940's



Joist History

1950's



Joist History

1960's

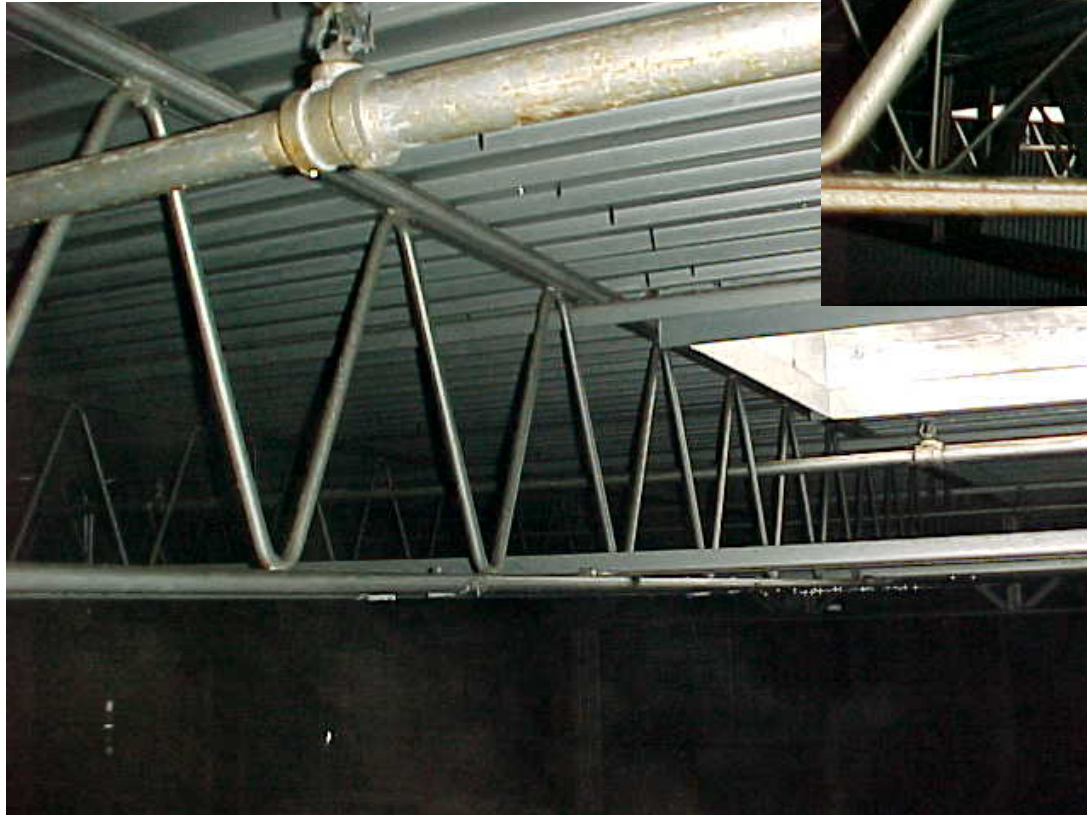
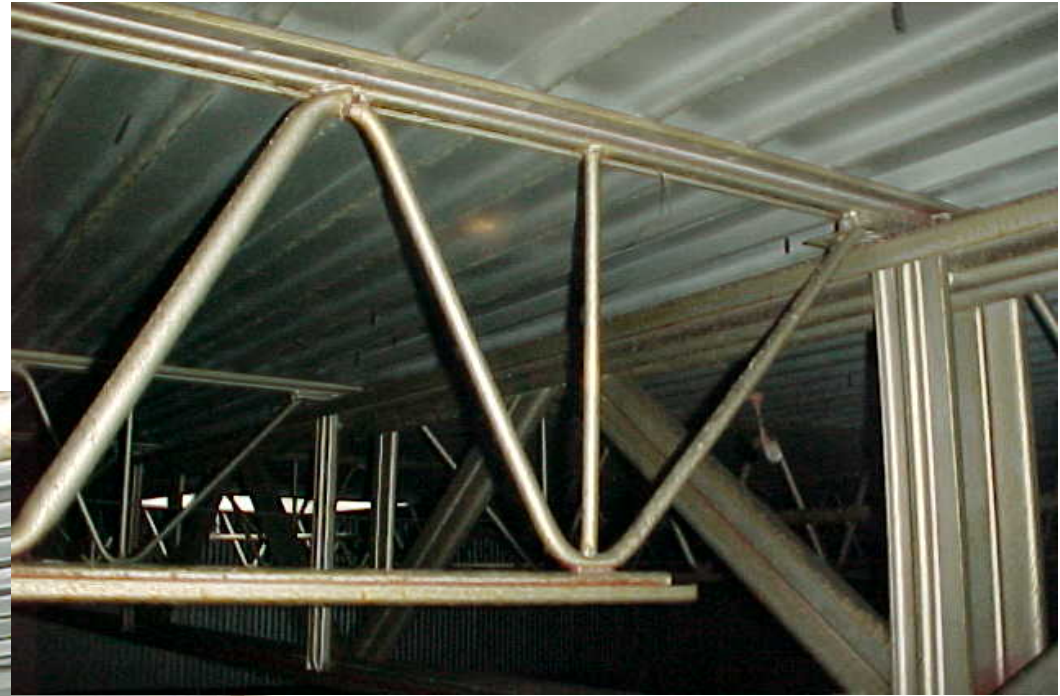

Joist History

1970's



Steel Joist Standard Specifications

ANSI SJI 100 - 2015

Standard Specification for K-Series, LH-Series and DLH-Series Open Web Steel Joists and for Joist Girders.

Current specification combines what were separate design specifications for the K-Series, the LH-/DLH-Series, and Joist Girders into a single specification.

Steel Joist Standard Specifications

ANSI/SJI-CJ-1.0

Standard Specifications for Composite Steel Joists, CJ-Series

Other SJI Documents

Code of Standard Practice for Steel Joists and Joist Girders (effective Jan. 2015)

ANSI/SJI-CJ COSP-1.0 (2018)

Code of Standard Practice for Composite Steel Joists

SJI Publications – Technical Digests

- TD No. 3 Structural Design of Steel Joist Roofs to Resist Ponding Loads (April 2017)
- TD No. 5 Vibration of Steel Joist – Concrete Slab Floors (January 2015)
- TD No. 6 Structural Design of Steel Joist Roofs to Resist Uplift Loads (April 2012)
- TD No. 8 Welding of Open Web Steel Joists (October 2008)
- TD No. 9 Handling and Erection of Steel Joists and Joist Girders (March 2008)

SJI Publications – Technical Digests

- TD No. 10 Design of Fire Resistive Assemblies with Steel Joists (2003)
- TD No. 11 Design of Lateral Load Resisting Frames Using Steel Joists and Joist Girders (November 2007)
- TD No. 12 Evaluation and Modification of Existing Steel Joists and Joist Girders (February 2007)
- TD No. 13 Design of Composite Steel Joists (2019)

Other SJI Publications

- 90 Years of Steel Joist Construction (CD): A Compilation of Specifications and Load Tables Since 1928.



Steel Joists and Joist Girders

- Introduction to Open-Web Steel Joists
- **Current Usage**
- Specification of Components





2015 Standard Specifications – Joist and Joist Girders

Section 1. Scope and Definition

Section 2. Referenced Specifications, Codes and Standards

Section 3. Materials

Section 4. Design and Manufacture

Section 5. Application

Section 6. Erection Stability and Handling

Standard Load Tables – LRFD and ASD (JG are weight tables)

Code of Standard Practice (COSP)

Appendix A - Fire Resistance Rating with Steel Joists

Appendix B – OSHA Steel Erection Standard

2015 Code of Standard Practice

- Section 1. General
- Section 2. Joists, Joist Girders and Accessories
- Section 3. Materials
- Section 4. Inspection
- Section 5. Estimating
- Section 6. Plans and Specifications
- Section 7. Handling and Erection
- Section 8. Business Relations

Scope & Definitions

Joist Girders, K-Series, LH-Series, and DLH-Series shall be open web, in-plane load-carrying steel members utilizing hot-rolled or cold-formed steel, including cold-formed steel whose yield strength has been attained by cold working.

Joist Girders shall be open web steel trusses used as primary framing members designed as simple spans supporting in-plane concentrated loads for a floor or roof system. These concentrated loads shall be considered to act at the top chord panel points of the **Joist Girders** unless otherwise specified.

Joist Girders shall be designed and manufactured as either simple framing members with underslung ends and bottom chord extensions or as part of an ordinary steel moment frame (OMF). Where used as part of an OMF the specifying professional shall be responsible for carrying out all the required frame analyses (i.e. first-order and second-order), provide all the required load information and stiffness data to the joist manufacturer, and indicate the type of **Joist Girder** to column connections that are being designed on the structural drawings.



2015 SJI Load Capacity Tables

Joist Series	Depth (in.)	Span (ft.)	Capacity (lbs/ft.)
K	10 - 30	10 - 60	Varies w/ Span
KCS	10 - 30	10 - 60	In terms of Moment and Shear
Substitutes	2.5 (*)	4 - 10	Varies w/ Span
LH	18 - 48	22 - 96	Varies w/ Span
DLH	52 - 120	62 - 240	Varies w/ Span



2015 SJI Load Capacity Tables

Joist Series	Depth (in.)	Span (ft.)	Capacity (lbs/ft.)
Joist Girders	20 - 120	20 - 120	Varies w/ Span
CJ	10 - 96	20 - 120	300 - 4500

Type of Web Members

Rod webs



Type of Web Members

Crimped Angle webs



Type of Web Members

Angles welded to the outside of chords



Bearing Condition

UNDERSLUNG

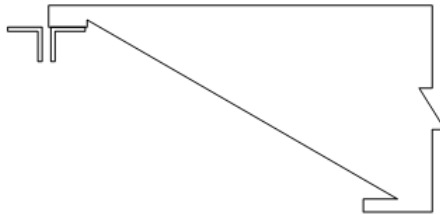

BOTTOM CHORD
BEARING

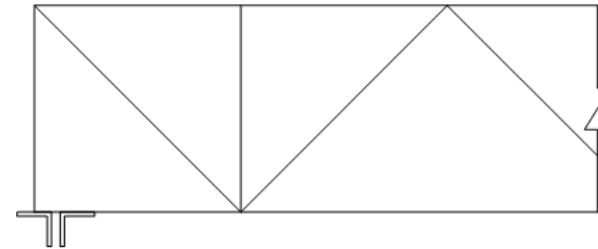

Bearing Condition Gone Wrong



Bearing Condition Gone Wrong



2015 Edition SJI Catalog - Accessories

Approximate Duct Sizes that will fit inside the webs of K-Series joist configurations

ACCESSORIES AND DETAILS

APPROXIMATE DUCT OPENING SIZES

JOIST DEPTH	ROUND	SQUARE	RECTANGLE
10 INCHES	5 INCHES	4 x 4 INCHES	3 x 7 INCHES
12 INCHES	7 INCHES	5 x 5 INCHES	3 X 8 INCHES
14 INCHES	8 INCHES	6 X 6 INCHES	5 X 9 INCHES
16 INCHES	8 INCHES	6 X 6 INCHES	5 X 9 INCHES
18 INCHES	9 INCHES	7 X 7 INCHES	5 X 9 INCHES
20 INCHES	10 INCHES	8 X 8 INCHES	6 X 11 INCHES
22 INCHES	10 INCHES	9 X 9 INCHES	7 X 11 INCHES
24 INCHES	12 INCHES	10 X 10 INCHES	7 X 13 INCHES
28 INCHES	15 INCHES*	12 X 12 INCHES*	9 X 18 INCHES*
28 INCHES	16 INCHES*	13 X 13 INCHES*	9 X 18 INCHES*
30 INCHES	17 INCHES*	14 X 14 INCHES*	10 X 18 INCHES*

SPECIFYING PROFESSIONAL MUST INDICATE ON STRUCTURAL DRAWINGS SIZE AND LOCATION OF ANY DUCT THAT IS TO PASS THRU JOIST. THIS DOES NOT INCLUDE ANY FIREPROOFING ATTACHED TO JOIST. FOR DEEPER LH- AND DLH- SERIES JOISTS, CONSULT MANUFACTURER.

*FOR ROD WEB CONFIGURATION, THESE WILL BE REDUCED. CONSULT MANUFACTURER.

2015 Edition SJI Catalog - Accessories

Duct thru the joist – It must be noted to align the joist panels and to keep the bridging out of the way.

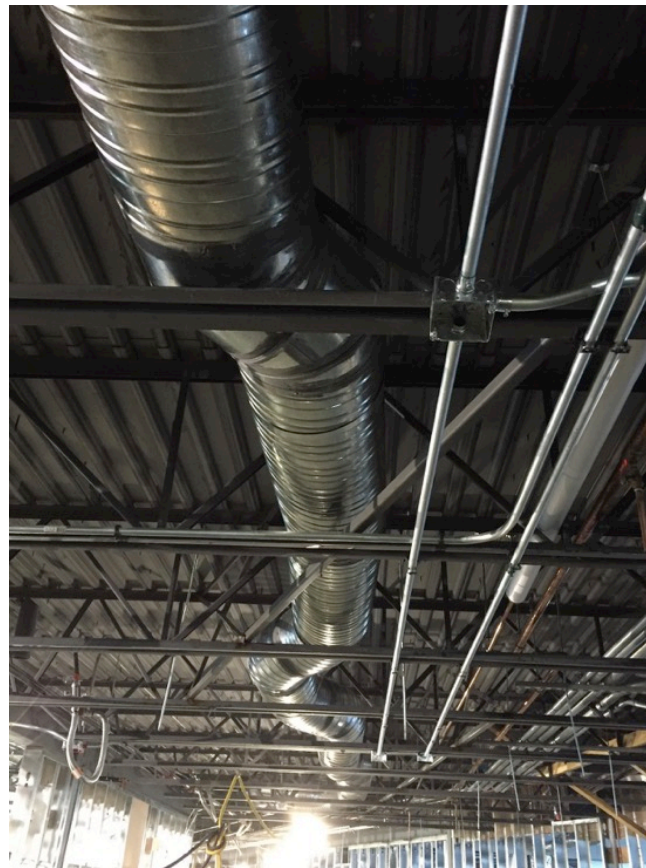

Types of Bridging

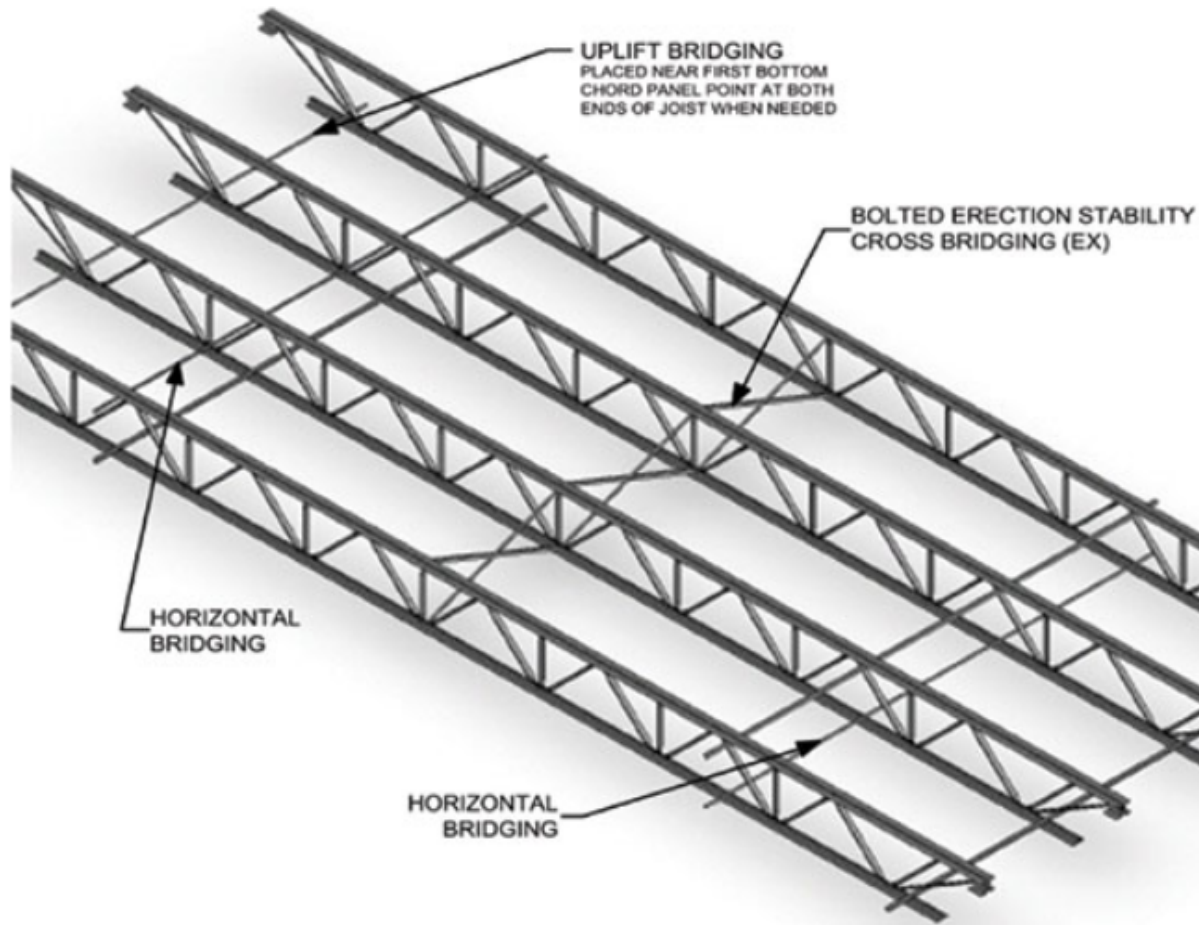

Joist Bridging Details

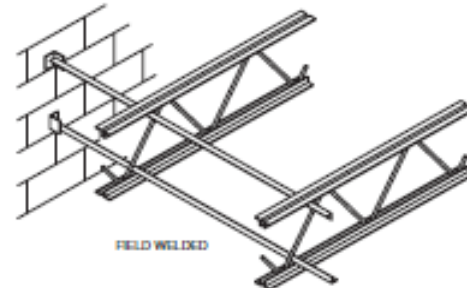

FIG. 6 - HORIZONTAL BRIDGING
SEE SJI SPECIFICATIONS

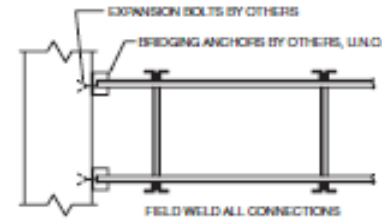

FIG. 6 - HORIZONTAL BRIDGING ANCHORAGE

NOTE: DO NOT WELD BRIDGING TO JOIST WEB MEMBERS. DO NOT HANG ANY MECHANICAL, ELECTRICAL, ETC. FROM BRIDGING.

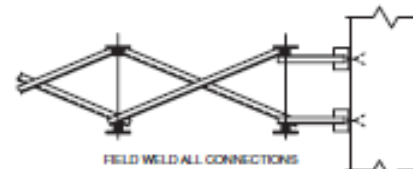

FIG. 7 - WELDED CROSS BRIDGING
SEE SJI SPECIFICATIONS

HORIZONTAL BRIDGING SHALL BE USED IN SPACE ADJACENT TO THE WALL TO ALLOW FOR PROPER DEFLECTION OF THE JOIST NEAREST THE WALL.

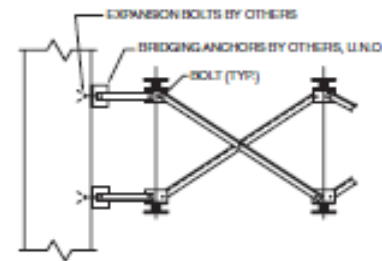

FIG. 8 - BOLTED CROSS BRIDGING
SEE SJI SPECIFICATIONS

(a) HORIZONTAL BRIDGING UNITS SHALL BE USED IN THE SPACE ADJACENT TO THE WALL TO ALLOW FOR PROPER DEFLECTION OF THE JOIST NEAREST THE WALL.

(b) CLIP CONFIGURATION MAY VARY FROM THAT SHOWN.

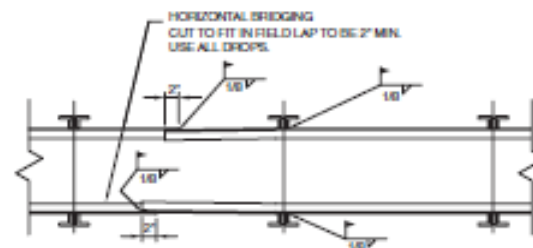
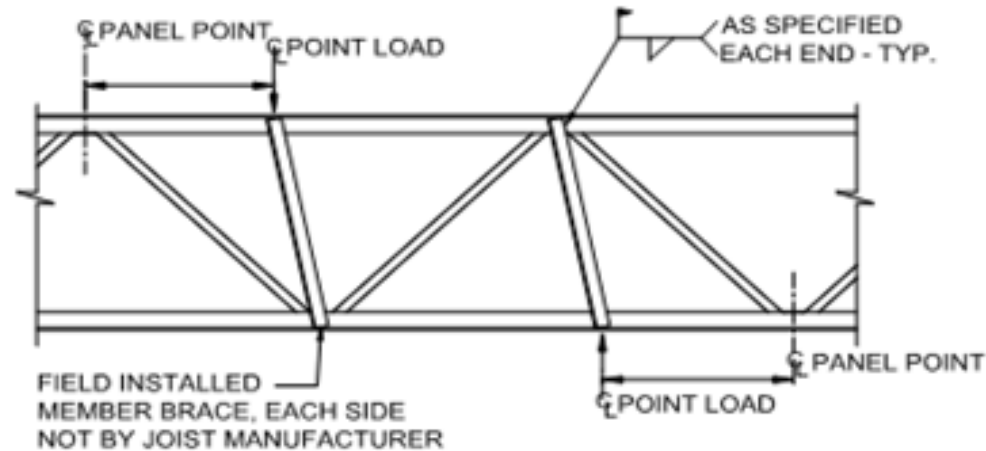

FIG. 9 - HORIZONTAL BRIDGING LAP JOINTS AND
ATTACHMENT TO JOISTS

100 Pound Rule

TYPICAL JOIST REINFORCEMENT AT CONCENTRATED LOADS



→ For nominal concentrated loads between panel points, which have been accounted for in the specified uniform design loads, a "strut" to transfer the load to a panel point on the opposite chord shall not be required, provided the sum of the concentrated loads within a chord panel does not exceed 100 pounds and the attachments are concentric to the chord.

100 Pound Rule

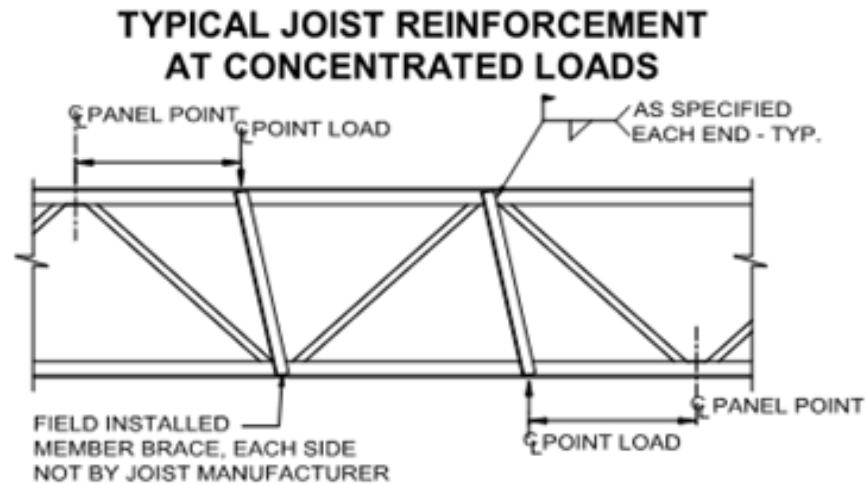

Although standard K-Series, including KCS-Series, and standard LH-Series joists are designed specifically to support uniformly distributed loads applied to the top chord, research conducted by the Steel Joist Institute, using second-order inelastic analysis, has demonstrated that the localized accumulation of uniform design loads of up to 100 pounds within any top or bottom chord panel has a negligible effect on the overall performance of the joist, provided that the load is applied to both chord angles in a manner which does not induce torsion on the chords.



Concentrated loads in excess of 100 pounds or which do not meet the criteria outlined above, must be applied at joist panel points, or field strut members must be utilized as shown in the detail above.

Add-Load

A single vertical concentrated load which occurs at any one panel point along the joist chord. This load is in addition to any other gravity loads.

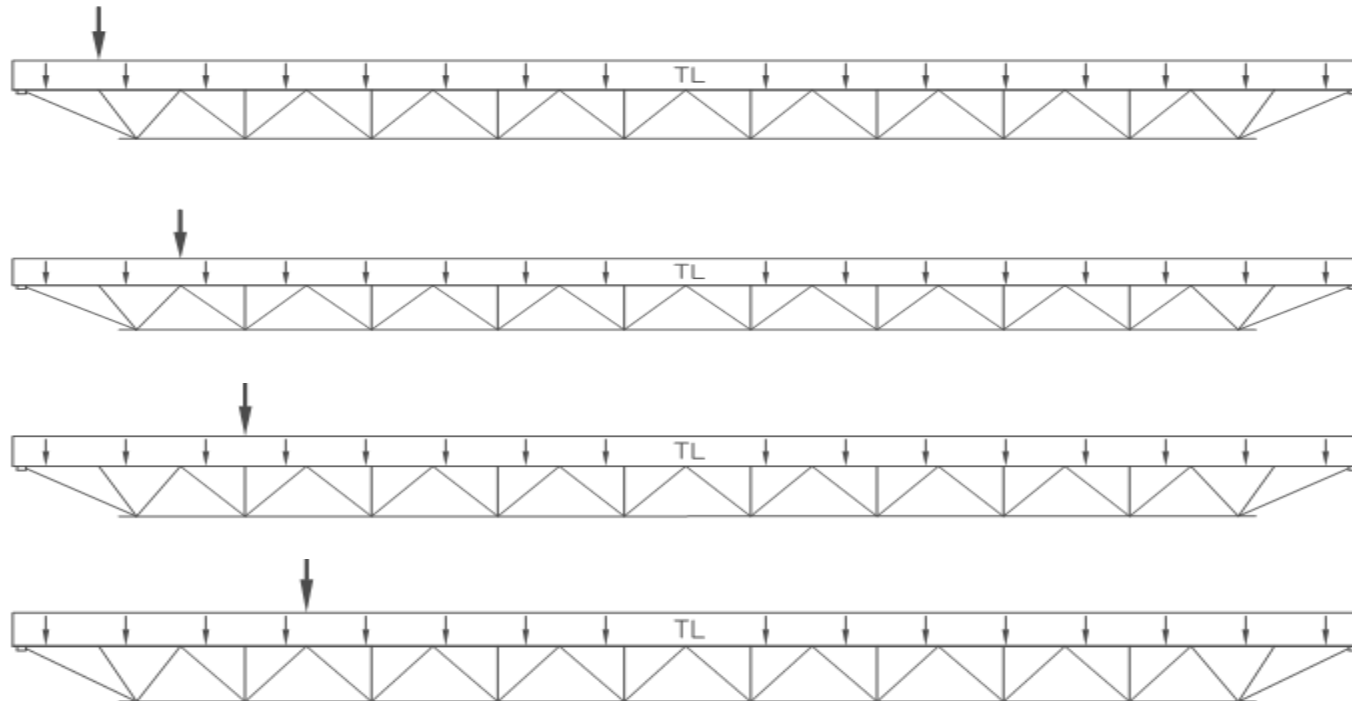

Bend-Check Load

A vertical concentrated load used to design the joist chord for the additional bending stresses resulting from this load being applied at any location between the joist panel points. This load shall be accounted for in the specified joist designation, uniform load or Add-load. It is used only for the additional bending check in the chord and does not contribute to the overall axial forces within the joist.

Top Chord Bend-Check Load

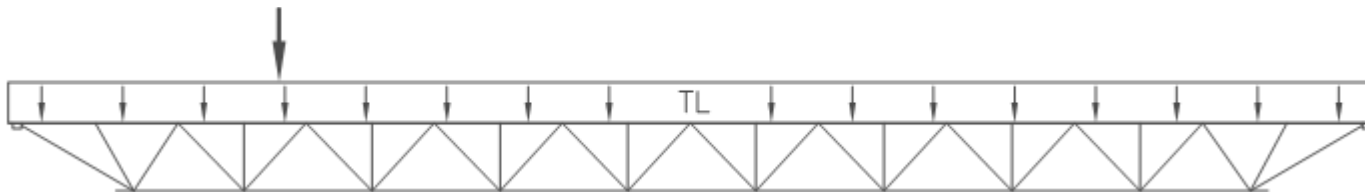
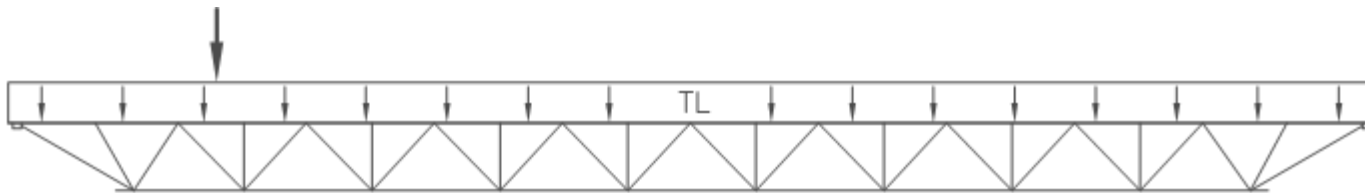
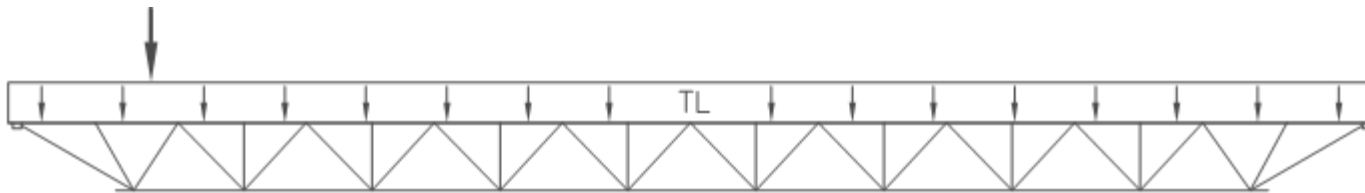
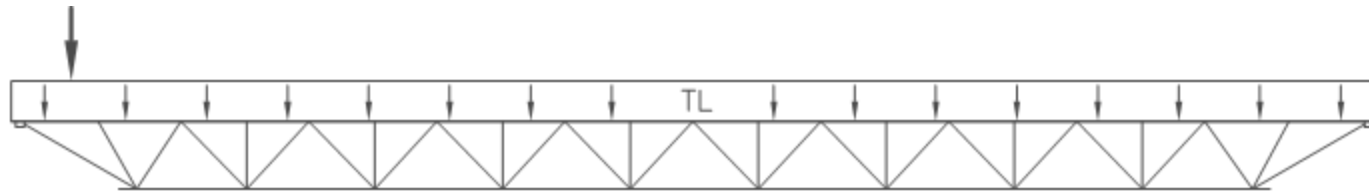

Bottom Chord Bend-Check Load

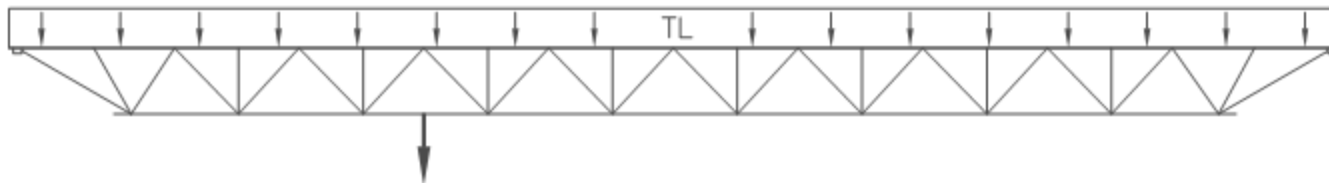
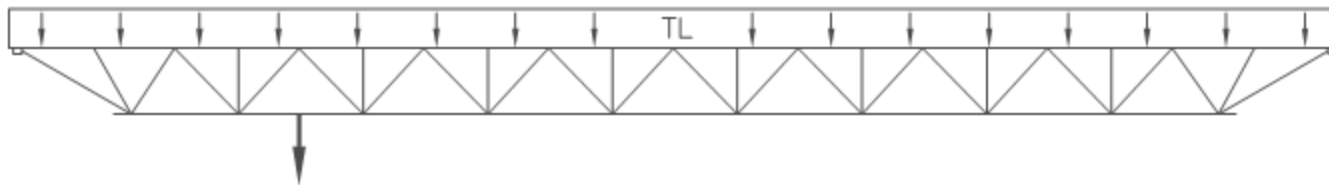
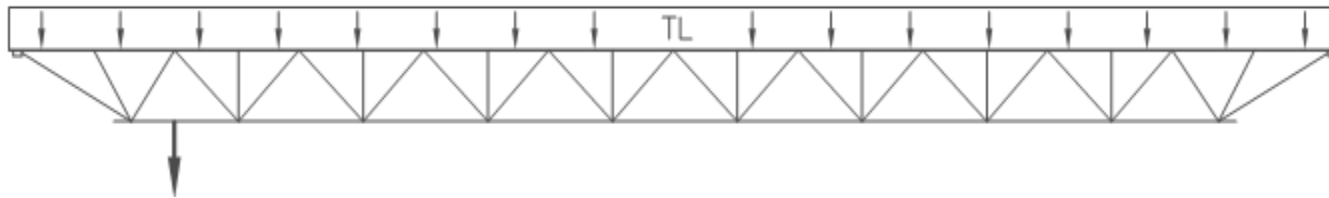

Joist Design Tools from the SJI

Steel Joist Institute Website has a design tools tab

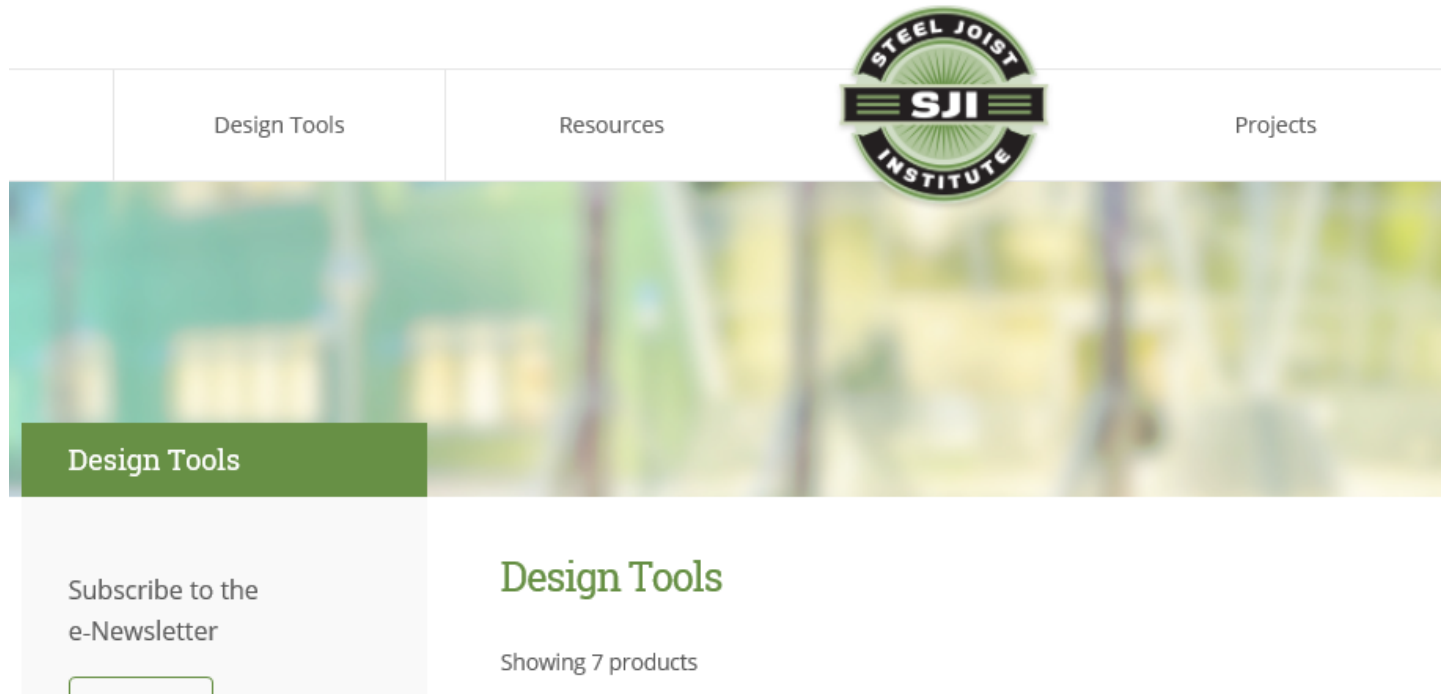

The image shows a screenshot of the Steel Joist Institute website. At the top, there is a navigation menu with four tabs: "Design Tools", "Resources", "Projects", and "SJI". The "SJI" logo is centered above the menu. The "Design Tools" tab is highlighted in green. Below the menu, there is a blurred background image of a building. In the foreground, there is a green box with the text "Design Tools" and a white box with the text "Subscribe to the e-Newsletter". To the right, there is a section titled "Design Tools" with the text "Showing 7 products".

Joist Design Tools from the SJI

Steel Joist Institute Website has a design tools tab

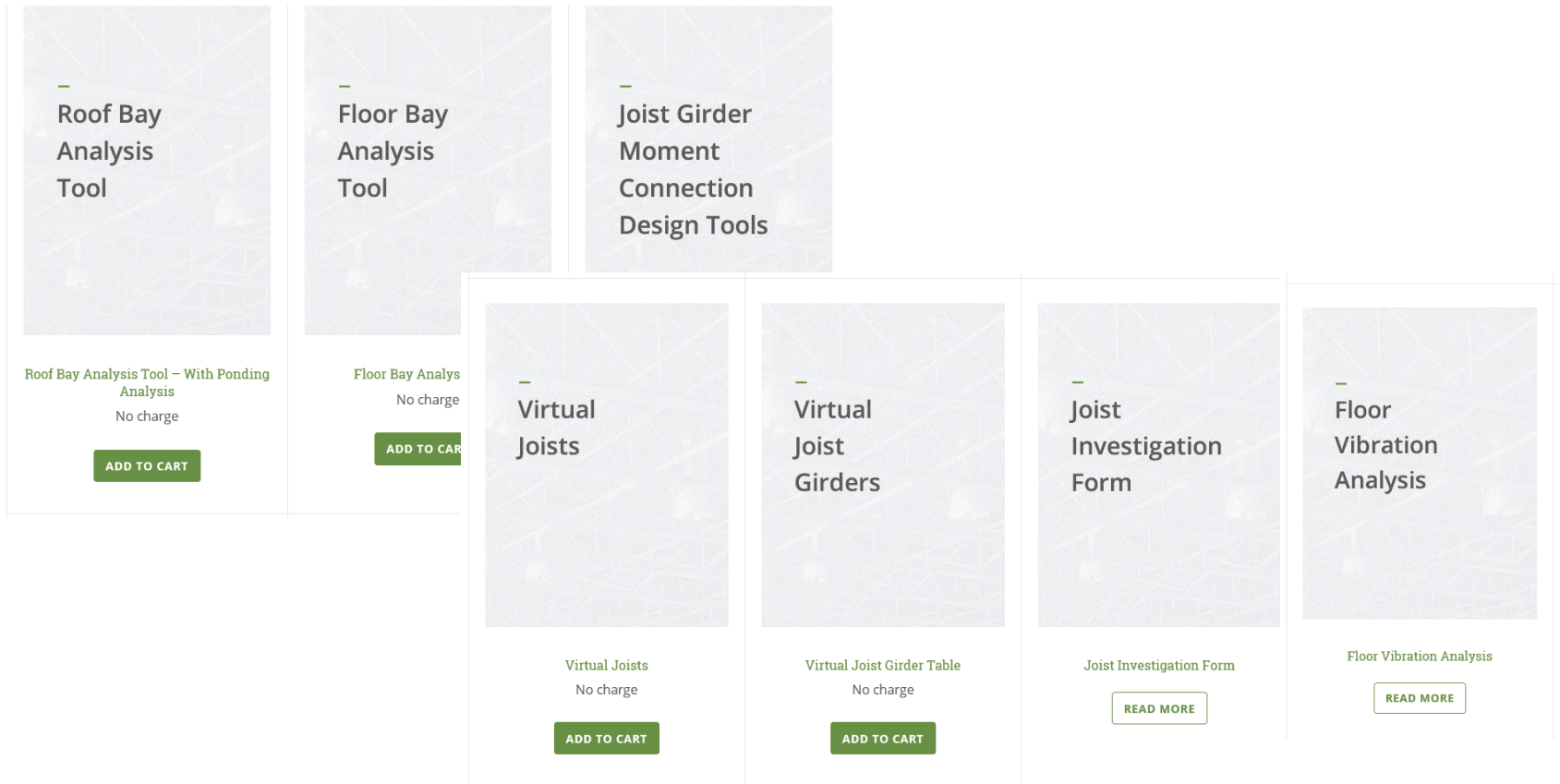

The screenshot displays a grid of design tool cards on the Steel Joist Institute website. Each card features a background image of a joist structure and contains the following information:

- Roof Bay Analysis Tool**
Roof Bay Analysis Tool – With Ponding Analysis
No charge
[ADD TO CART](#)
- Floor Bay Analysis Tool**
Floor Bay Analysis
No charge
[ADD TO CART](#)
- Joist Girder Moment Connection Design Tools**
- Virtual Joists**
Virtual Joists
No charge
[ADD TO CART](#)
- Virtual Joist Girders**
Virtual Joist Girder Table
No charge
[ADD TO CART](#)
- Joist Investigation Form**
Joist Investigation Form
[READ MORE](#)
- Floor Vibration Analysis**
Floor Vibration Analysis
[READ MORE](#)

Joist Design Tools from the SJI

Steel Joist Institute Design Tools include:

1. Roof Bay Analysis Tool
2. Floor Bay Analysis Tool
3. Joist Girder Moment Connection Design Tool
4. Virtual Joists
5. Virtual Joist Girders
6. Joist Investigation Form
7. Floor Vibration Analysis

Joist Design Tools from the SJI

Steel Joist Institute Design Tools webinar:

All of these tools have had webinars explaining how they work.

See the SJI On Demand Webinar

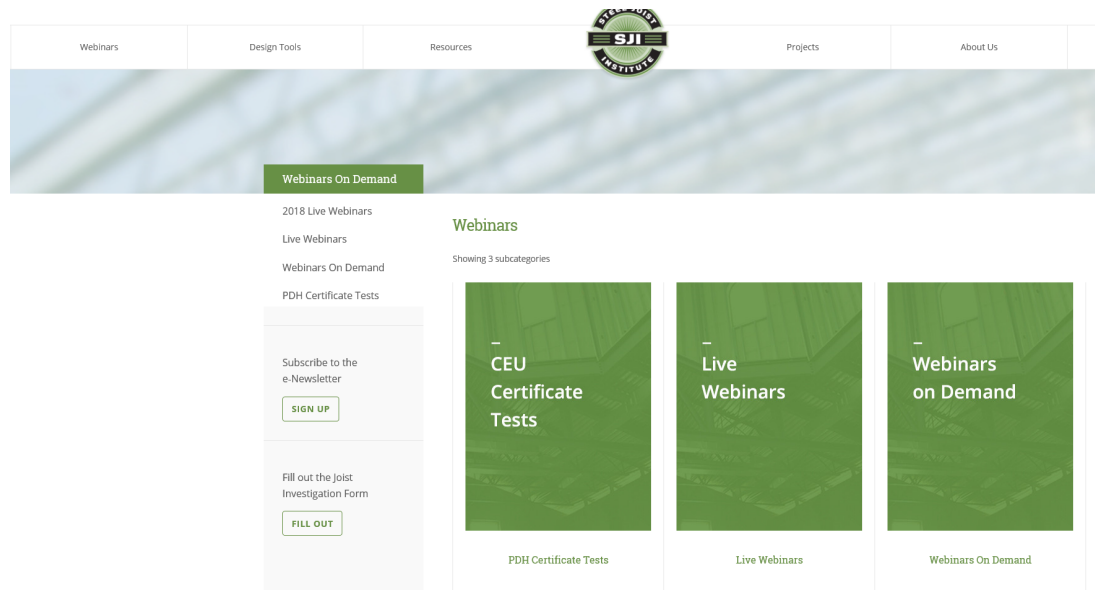

The screenshot displays the Steel Joist Institute website's navigation and content. The top navigation bar includes links for Webinars, Design Tools, Resources, Projects, and About Us. The main content area features a sidebar with a 'Webinars On Demand' button and a list of categories: 2018 Live Webinars, Live Webinars, Webinars On Demand, and PDH Certificate Tests. Below this is a 'Subscribe to the e-Newsletter' section with a 'SIGN UP' button, and a 'Fill out the Joist Investigation Form' section with a 'FILL OUT' button. The main content area is titled 'Webinars' and shows 'Showing 3 subcategories' with three green cards: 'CEU Certificate Tests', 'Live Webinars', and 'Webinars on Demand'. Each card has a corresponding label below it: 'PDH Certificate Tests', 'Live Webinars', and 'Webinars On Demand'.

Joist Design Tools from the SJI

Steel Joist Institute Design Tools webinar:

See the SJI Webinars On Demand

<p>Webinar on Demand</p> <p>Joist Girder Moment Connections to HSS Columns</p> <p>Joist Girder Moment Connections to HSS Columns</p> <p>Free!</p> <p>SELECT AN OPTION</p>	<p>Webinar on Demand</p> <p>Joist Girder Moment Connections to W-Shaped Columns</p> <p>Joist Girder Moment Connections to W-Shaped Columns</p> <p>Free!</p> <p>SELECT AN OPTION</p>	<p>Webinar on Demand</p> <p>Using Virtual Joist Girders for Building Modeling and Design</p> <p>Using Virtual Joist Girders for Building Modeling and Design</p> <p>Free!</p> <p>SELECT AN OPTION</p>
--	--	--

Polling Question 1

In what year did SJI combine the K, LH, and JG design specification?

- A. 2000
- B. 2005
- C. 2010
- D. 2015

Steel Joists and Joist Girders

- Introduction to Open-Web Steel Joists
- Current Usage
- **Specification of Components**



Specification of Components

- **K-Series and KCS Joists and other related accessories**
- LH- and DLH-Series Joists
- Joist Girders
- Properly Specifying Steel Joists and Joist Girders



K-Series

- K-Series, KCS Design Background
- K-Series, KCS Standard Products
- Joist Substitutes
- Top Chord Extensions and Extended Ends



K-Series Background

- **Maximum Span in Feet = 2 x Depth in Inches**
20 in. deep joist has a maximum Span = 40 ft.
- **Top Chords designed for axial force and local bending between panel points from uniform loads.**
- **For joist with uniform loads the maximum chord force is determined by $WL^2/8$.**
- **For gravity loads compression in the top chord and tension in the bottom chord.**
- **For upward wind loads tension in the top chord and compression in the bottom chord.**

K-Series Background

Linear Shear is carried by the webs

- Webs designed as pinned-end members for axial tension and/or compression based on linear shear.
- Forces are reversed for downward and upward loads.
- Webs design for Minimum Shear = to 25% of the maximum end reaction.
- No standard stress reversal check.

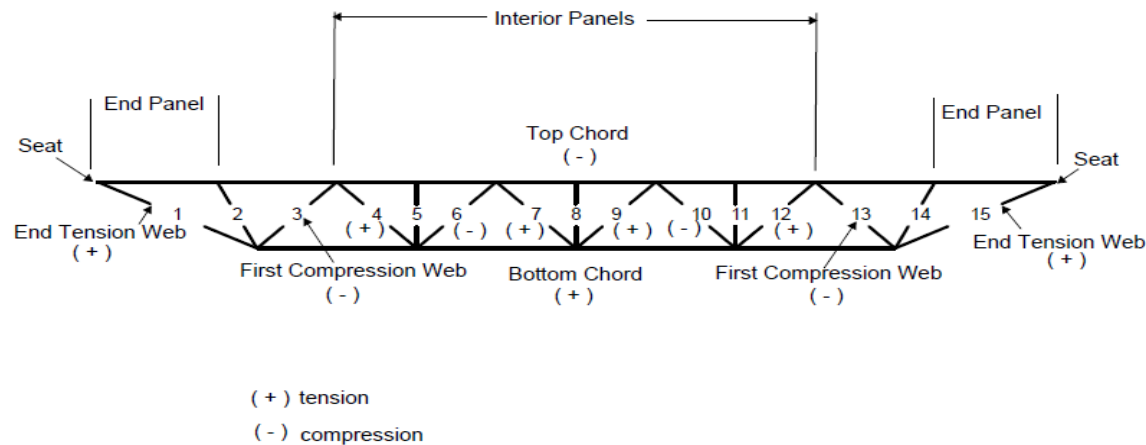

K-Series Background

- **Basis of K-Series Joists**

The **K-Series**, **LH-Series** and **DLH-Series** standard joist designations shall be established by their nominal depth, followed by the letters **K**, **LH** or **DLH** as appropriate, and then by the Section Number designation assigned. The Section Number designations shall range from 01 to 25. The **K-Series**, **LH-Series** and **DLH-Series** standard joist designations listed in the following Standard Load Tables shall support the uniformly distributed loads as provided in the applicable tables. In the tables live loads are based on deflection. Careful consideration must be made.

ASD

STANDARD LOAD TABLE FOR OPEN WEB STEEL JOISTS, K-SERIES															
Based on a 50 ksi Maximum Yield Strength - Loads Shown In Pounds Per Linear Foot (plf)															
Joist Designation	24K4	24K5	24K6	24K7	24K8	24K9	24K10	24K12	26K5	26K6	26K7	26K8	26K9	26K10	26K12
Depth (In.)	24	24	24	24	24	24	24	24	26	26	26	26	26	26	26
Approx. Wt. (lbs./ft.)	7.8	7.9	8.5	9.0	9.4	10.3	11.7	13.5	8.1	8.6	9.0	9.7	10.4	11.8	13.7
Span (ft.)															
↓															
23	550	550	550	550	550	550	550	550							
	550	550	550	550	550	550	550	550							
24	520	550	550	550	550	550	550	550							
	516	544	544	544	544	544	544	544							
25	479	540	550	550	550	550	550	550	550	550	550	550	550	550	550
	456	511	520	520	520	520	520	520	550	550	550	550	550	550	550
26	442	499	543	550	550	550	550	550	542	550	550	550	550	550	550
	405	453	493	499	499	499	499	499	535	541	541	541	541	541	541
27	410	462	503	550	550	550	550	550	502	547	550	550	550	550	550
	361	404	439	479	479	479	479	479	477	519	522	522	522	522	522
28	381	429	467	521	550	550	550	550	466	508	550	550	550	550	550
	323	362	393	436	456	456	456	456	427	464	501	501	501	501	501
29	354	400	435	485	536	550	550	550	434	473	527	550	550	550	550
	290	325	354	392	429	436	436	436	384	417	463	479	479	479	479

K-Series Joists

- Designations: 10K1 to 30K12
- Depths: 10 to 30 in.
- Standard Seat Depth (Height): 2.5 in.
- Span Range: 10 to 60 ft.
- ASD Load Range: 127 to 550 plf
- LRFD Load Range: 190 to 825 plf
- Maximum Span/Depth Ratio: 24

Alternate Specification Method

An alternate method of specifying a standard **K-Series**, **LH-Series**, or **DLH-Series** joist shall be permitted by providing the designation in a “load/load” sequence. The format used shall be **ddKtl/ll**, **ddLHtl/ll**, or **ddDLHtl/ll** where:

- **dd** is the depth of the joist in **inches**.
- **K-LH-DLH** is the joist series
- **tl** is the total load in **plf**. (pounds per linear foot)
- **ll** is the live load in **plf**. (pounds per linear foot)

An example: 24K300/175

Note: Uplift must be specified independent to the designation.

KCS Joists Background

- KCS Joists are a K-Series Joist
- Maximum Span in Feet = 2 x Depth in Inches
- Maximum Depth = 30" Maximum Span = 60 feet
- Simply Supported Trusses
- Chord Forces based on Constant Moment Capacity. The moment is not directly based from uniform loads.
- Maximum uniform load = 550 plf (ASD) 825 plf (LRFD)

KCS Joists Background

- Web Forces based on Constant Shear Capacity, not shear due to uniform load
- Minimum Shear = 100% of Shear Capacity
- All Webs designed for compression (load reversal) except end web.
- **Shall be parallel chord only.**
- May be underslung or bottom chord end bearing.
- Gross Moment of Inertia from Tables can be used for deflection checks.
- Single concentrated load shall not exceed shear capacity in tables.

KCS Joists

- Designations: 10KCS1 to 30KCS5
- Depths: 10 to 30 in.
- Seat Depth (Height): 2.5 in.
- Span Range: 10 to 60 ft.
- Constant Moment Capacity
- Constant Shear Capacity
- Maximum Span/Depth: 24

KCS Load Table

ASD

STANDARD LOAD TABLE FOR KCS OPEN WEB STEEL JOISTS							
Based on a 50 ksi Maximum Yield Strength							
JOIST DESIGNATION	DEPTH (in.)	MOMENT CAPACITY (k-in.)	SHEAR CAPACITY* (lbs)	APPROX. WEIGHT** (lbs/ft.)	GROSS MOMENT OF INERTIA (in ⁴)	ERECTION STABILITY BRIDGING REQ'D (ft.)	BRIDGING TABLE SECTION NUMBER
10KCS1	10	172	2000	6.0	29	NA	1
10KCS2	10	225	2500	7.5	37	NA	1
10KCS3	10	296	3000	10.0	47	NA	1
12KCS1	12	209	2400	6.0	43	NA	3
12KCS2	12	274	3000	8.0	55	NA	5
12KCS3	12	362	3500	10.0	71	NA	5

KCS Joists

KCS- Series joist advantages:

1. Provides a versatile **K-Series** Joist that can be easily specified to support uniform and non-uniform loads plus concentrated loads applied at panel points.
2. Eliminate many repetitive load diagrams required on contract documents and allow some flexibility of load locations.

KCS-Series joist chords are designed for a flat positive moment envelope. The moment capacity is constant at all interior panels.

All webs are designed for a vertical shear equal to the specified shear capacity and interior webs will be designed for 100% stress reversal.

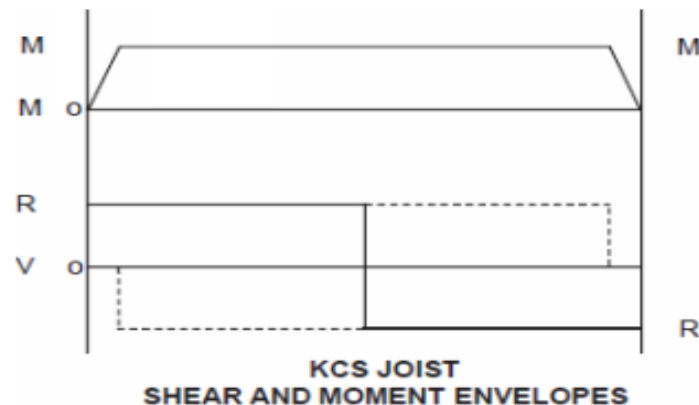

Both LRFD and ASD **KCS-**Series joist load tables list the shear and moment capacity of each joist. The selection of a **KCS-**Series Joist requires the specifying professional to calculate the maximum moment and shear imposed and select the appropriate **KCS-** Series Joist.

Joist Substitutes

Used where Open Web Steel Joist may not be applicable.

Standard depth = 2.5". Deeper depths may be available from joist manufacturer.

(Joist) Spans 10 feet or less

Joist Substitutes standard depths are 2.5 inches and may have extended ends for overhangs (outriggers).

“Double” joist substitutes can be used to obtain capacities other than those in the Load Table, or the spacing can be varied.

Joist Substitutes

Typical 2 ½ in. deep Joist Substitutes

Hot-Rolled

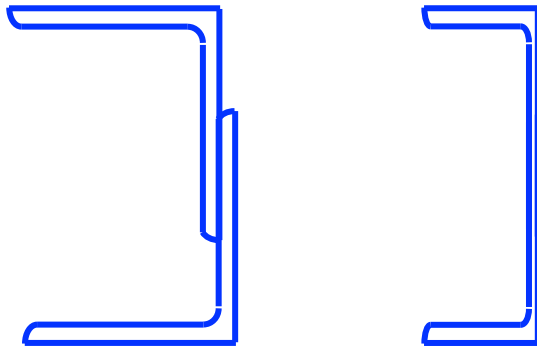

Cold-Formed

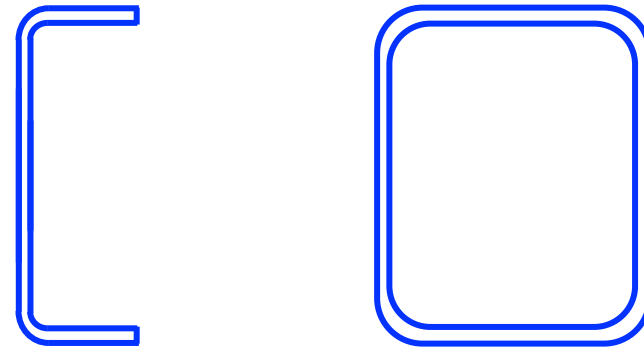

Joist Substitutes Load Tables

ASD

LOAD TABLES FOR 2.5 INCH SIMPLE SPAN JOIST SUBSTITUTES, K-SERIES			
Based on a Maximum Yield Strength of 50 ksi			
Designation	2.5K1	2.5K2	2.5K3
Span (ft-in)	Pounds per Linear Foot		
4'-0"	550	550	550
	550	550	550
5'-0"	550	550	550
	326	452	550
6'-0"	386	536	550
	182	253	354
7'-0"	279	387	540
	112	155	218
8'-0"	211	293	408
	73	102	143
9'-0"	0	229	320
	0	71	99
10'-0"	0	0	257
	0	0	71

LRFD

LOAD TABLES FOR 2.5 INCH SIMPLE SPAN JOIST SUBSTITUTES, K-SERIES			
Based on a Maximum Yield Strength of 50 ksi			
Designation	2.5K1	2.5K2	2.5K3
Span (ft-in)	Pounds per Linear foot		
4'-0"	825	825	825
	550	550	550
5'-0"	825	825	825
	326	452	550
6'-0"	579	804	825
	182	253	354
7'-0"	418	580	810
	112	155	218
8'-0"	316	439	612
	73	102	143
9'-0"	0	343	480
	0	71	99
10'-0"	0	0	385
	0	0	71

Top Chord Extensions and Extended Ends

Top Chord (S Extensions)

Joist End (R Extensions)

Special Seat Depth Extensions



Top Chord Extensions

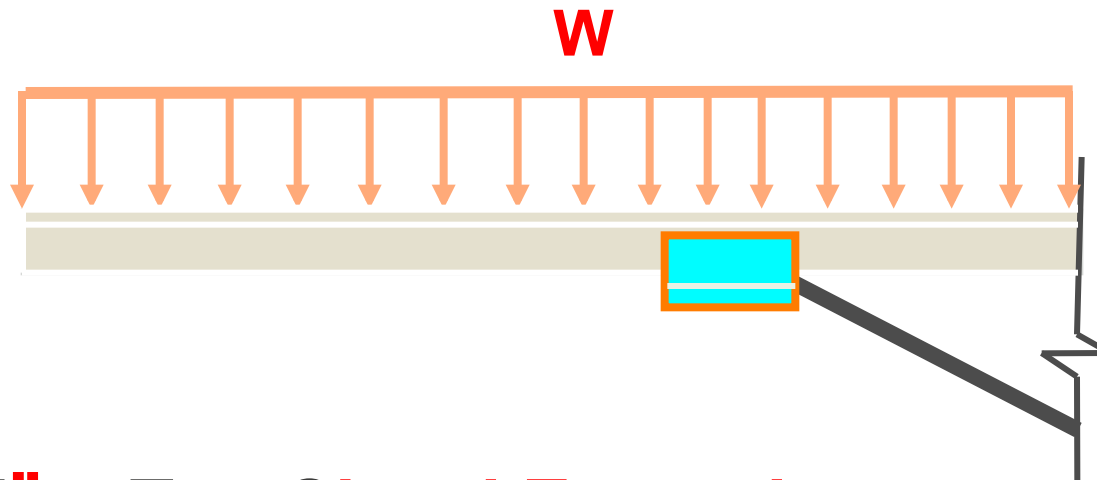

“TCX” = Top Chord Extension



Un-Reinforced

“S” or Standard

Top Chord Extensions

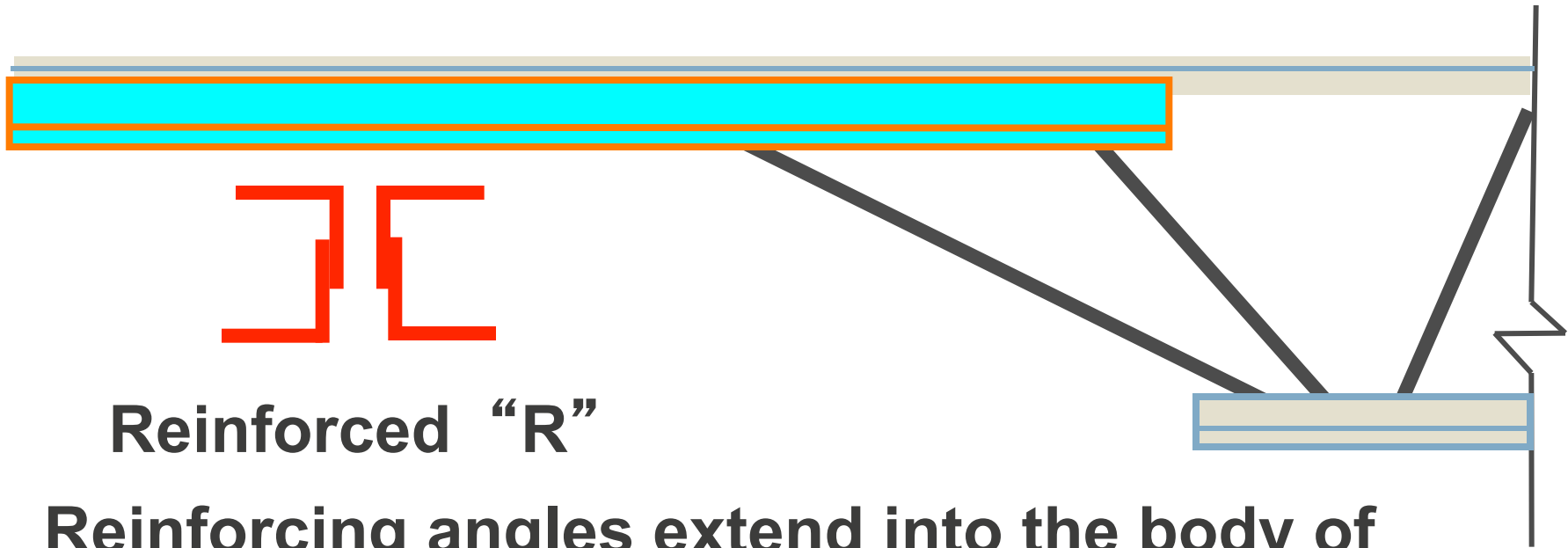

Reinforced “R”

Reinforcing angles extend into the body of joist

Top Chord Extensions

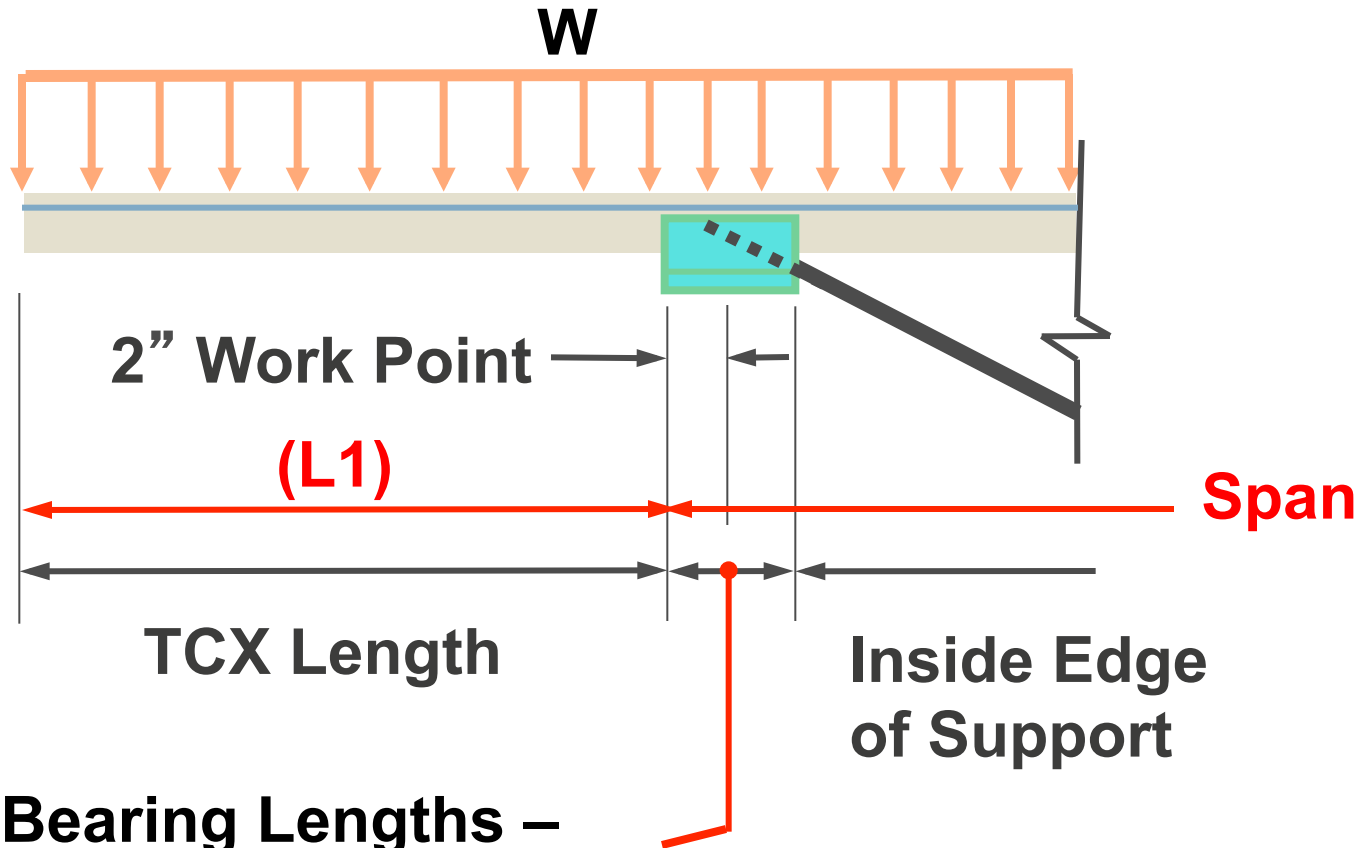

**Standard Bearing Lengths –
4" for K-Series; 6" for all Others**

Top Chord Extension Load Tables

4. Loads were back-calculated using the properties of the angles and:
 - a. ASD Allowable Stress of $0.6F_y = 30,000$ psi
 - b. LRFD Design Stress of $0.9F_y = 45,000$ psi

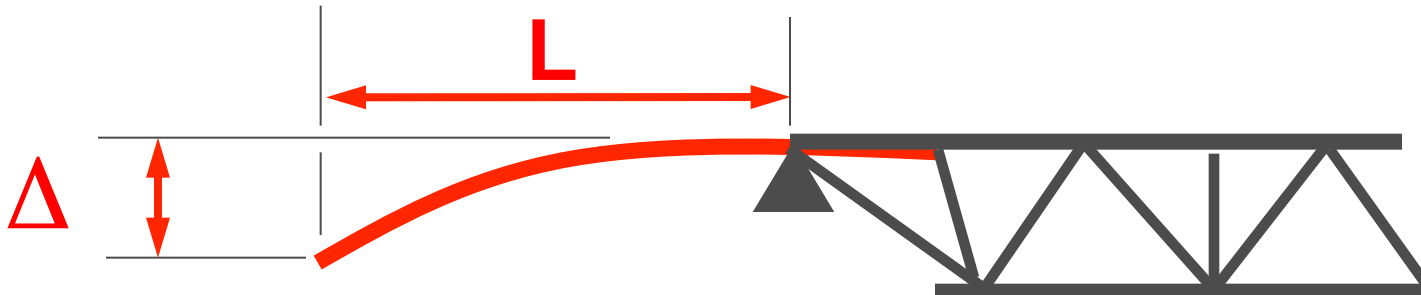

TCX ASD and LRFD S-Type Load Tables

ASD

TOP CHORD EXTENSION LOAD TABLE (S TYPE)											
Based on a Maximum Yield Strength of 50 ksi											
Pounds Per Linear Foot											
TYPE	"S" (in. ³)	"I" (in. ⁴)	LENGTH (L1)								
			0'-6"	1'-0"	1'-6"	2'-0"	2'-6"	3'-0"	3'-6"	4'-0"	4'-6"
S1	0.099	0.088	550	363	178	105					
S2	0.127	0.138									
S3	0.144	0.156									
S4	0.160	0.172									
S5	0.176	0.188									
S6	0.192	0.204									
S7	0.241	0.306									
S8	0.266	0.332									
S9	0.288	0.358									
S10	0.380	0.544									
S11	0.438	0.622									
S12	0.494	0.696									

LRFD

TOP CHORD EXTENSION LOAD TABLE (S TYPE)											
Based on a Yield Strength of 50 ksi											
Pounds Per Linear Foot											
TYPE	"S" (in. ³)	"I" (in. ⁴)	LENGTH (L1)								
			0'-6"	1'-0"	1'-6"	2'-0"	2'-6"	3'-0"	3'-6"	4'-0"	4'-6"
S1	0.099	0.088	825	544	267	157					
S2	0.127	0.138	825	700	343	202					
S3	0.144	0.156	825	793	388	229					
S4	0.160	0.172	825	825	432	255	168				
S5	0.176	0.188	825	825	474	280	184				
S6	0.192	0.204	825	825	517	306	202				
S7	0.241	0.306	825	825	649	384	253	180			
S8	0.266	0.332	825	825	717	424	280	198			
S9	0.288	0.358	825	825	777	459	303	214	160		
S10	0.380	0.544	825	825	825	606	400	283	211	163	
S11	0.438	0.622	825	825	825	699	460	327	243	189	150
S12	0.494	0.696	825	825	825	789	520	369	274	213	169

TCX ASD and LRFD R-Type Load Tables

ASD

TOP CHORD EXTENSION LOAD TABLE (R TYPE)
Based on a Yield Strength of 50 ksi
Pounds Per Linear Foot

TYPE	"S" (in. ³)	"I" (in. ⁴)	LENGTH (L1)											
			0'-6"	1'-0"	1'-6"	2'-0"	2'-6"	3'-0"	3'-6"	4'-0"	4'-6"	5'-0"	5'-6"	6'-0"
R1	0.895	1.119	550	550	550	550	448	333	257	205	167	130	117	
R2	0.923	1.157	550											
R3	1.039	1.299	550											
R4	1.147	1.433	550											
R5	1.249	1.561	550											
R6	1.352	1.690	550											
R7	1.422	1.802	550											
R8	1.558	1.948	550											
R9	1.673	2.091	550											
R10	1.931	2.414	550											
R11	2.183	2.729	550											
R12	2.413	3.016	550											

LRFD

TOP CHORD EXTENSION LOAD TABLE (R TYPE)
Based on a Yield Strength of 50 ksi
Pounds Per Linear Foot

TYPE	"S" (in. ³)	"I" (in. ⁴)	LENGTH (L1)											
			0'-6"	1'-0"	1'-6"	2'-0"	2'-6"	3'-0"	3'-6"	4'-0"	4'-6"	5'-0"	5'-6"	6'-0"
R1	0.895	1.119	825	544	825	157	825	669	498	385	307	250	208	175
R2	0.923	1.157	825	700	343	202	825	690	514	399	318	259	216	181
R3	1.039	1.299	825	793	388	229	825	777	579	448	358	292	243	205
R4	1.147	1.433	825	825	825	825	825	825	639	495	394	321	267	225
R5	1.249	1.561	825	825	825	280	184	825	696	538	429	349	291	246
R6	1.352	1.690	825	825	517	825	202	825	753	583	465	379	315	265
R7	1.422	1.802	825	825	649	825	253	825	792	613	489	399	331	279
R8	1.558	1.948	825	825	825	424	280	825	825	672	535	436	363	306
R9	1.673	2.091	825	825	825	825	825	214	160	721	576	469	390	328
R10	1.931	2.414	825	825	825	825	400	283	211	163	664	541	450	379
R11	2.183	2.729	825	825	825	825	460	825	825	825	751	612	508	430
R12	2.413	3.016	825	825	825	825	520	825	274	825	169	676	562	475

TCX S-Type

TYPE	"S" (in. ³)	"I" (in. ⁴)
S1	0.099	0.088
S2	0.127	0.138
S3	0.144	0.156



Moment of Inertia is I_{x-x}

Section Modulus is the Minimum (at the toe)

R-Type

TYPE	"S" (in. ³)	"I" (in. ⁴)
R1	0.895	1.119
R2	0.923	1.157
R3	1.039	1.299

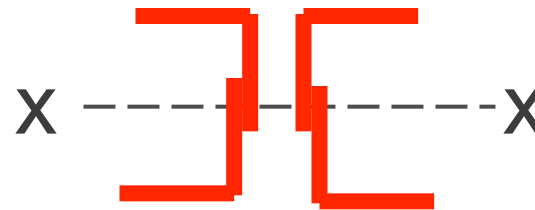

“R1”
Combination
of Top and
Reinforcing
Angle

Section
Depth is
2.5 inches

Section Modulus is the Minimum for the Section

S << R Type Capacity

Joist Extensions with Non-Uniform Loads

TCX Load Diagram

$P = 750 \text{ lbs (DL)}$

$w = 300/150 \text{ lbs/ft.}$

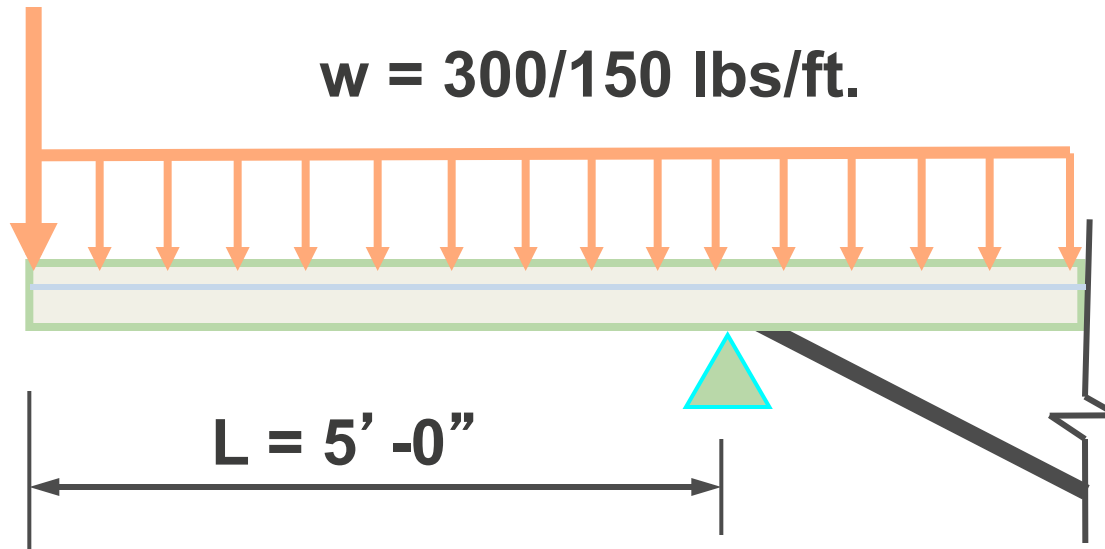

Verifying Seat Depths

- The maximum unfactored end reaction that a K joist can have with a 2.5 in. joist seat depth is approximately 9.2 kips.

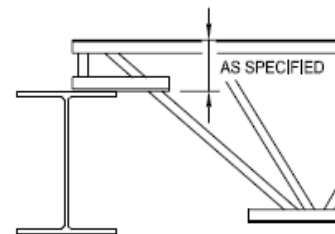
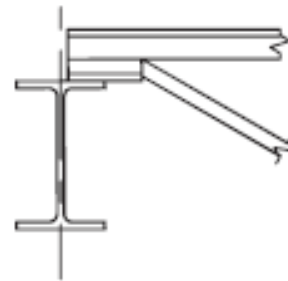

- Special depth bearing seats are far less expensive than seats that aren't deep enough.

Joist Extensions

Seat Depth at Sloped TCX

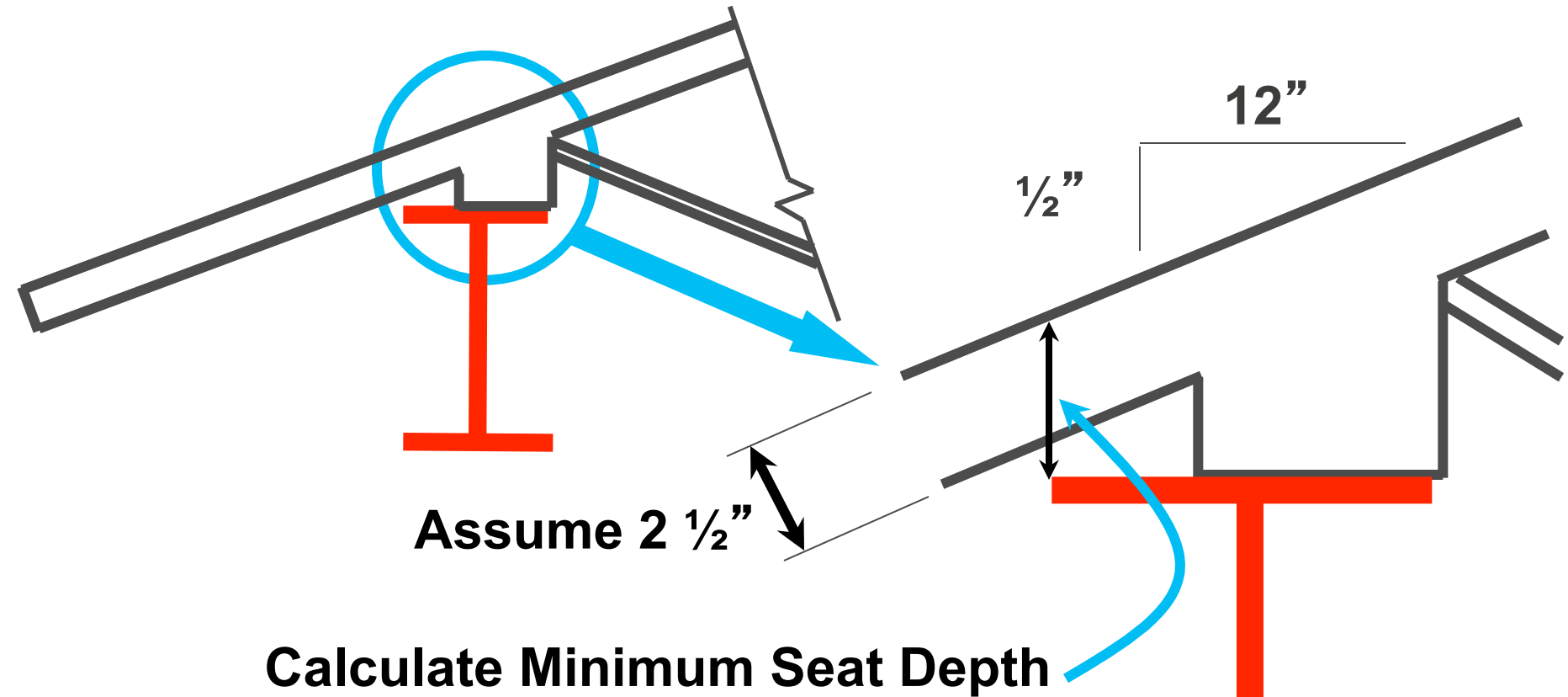

**Calculate Minimum Seat Depth
based on Top Chord Pitch**

Top Chord Extensions Summary

- ❖ K-series joists have an upper load capacity of 550 plf ASD or 825 plf LRFD.
- ❖ Depending on length (and seat depth) it may be difficult to provide a TCX for 550 plf ASD or 825 plf LRFD.
- ❖ Specify an extension Section, S1 to S12, or R1 to R12, whenever possible.
- ❖ Essentially, you are specifying the minimum required structural properties.

Top Chord Extensions Summary

- ❖ For non-uniform loads, calculate S and $I_{\text{req'd}}$ and select an extension based on the required properties. If R12 properties are not sufficient, contact joist manufacturer.
- ❖ If larger cross-sectional properties are required, increase seat depth.
- ❖ Since the “chord number” on the joist designation (5 in 24K5) and the number on the extension type (10 in R10) are only relative, if a larger extension type (R12) is specified on a smaller joist (18K3) the size of the top chord may be determined based on the TCX requirement which may significantly increase the cost of the joist.

Joist Seats and the Reaction

Joist bearing is 2" from the base length of the joist.

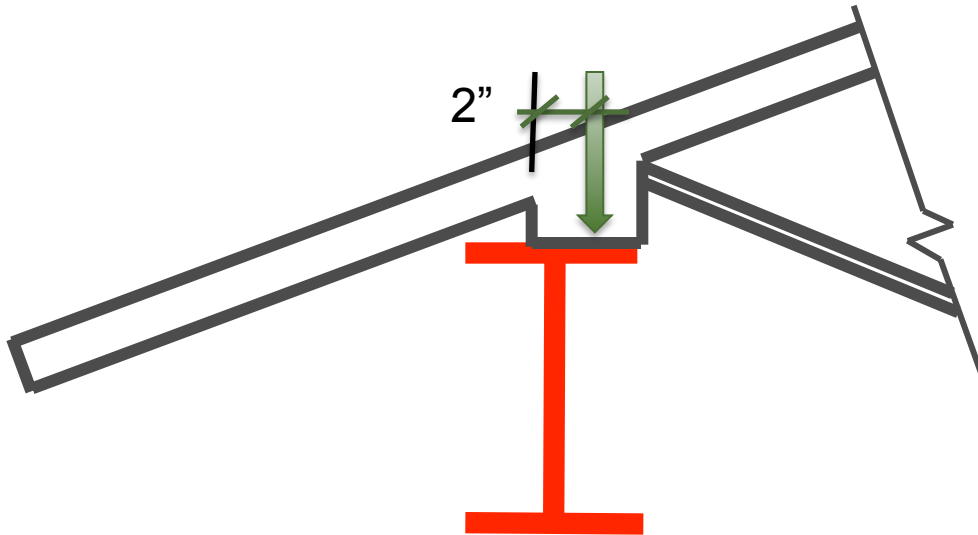

Unless noted to do so the joist reaction will occur at 2" from the base length of the joist, not at the center of the support.

In order to get the reaction over the center of the support the bearing depth must be increased.

Joist Seats

Joist bearing seats can be sloped but not canted.

Sloped seat.

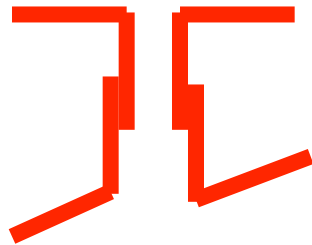
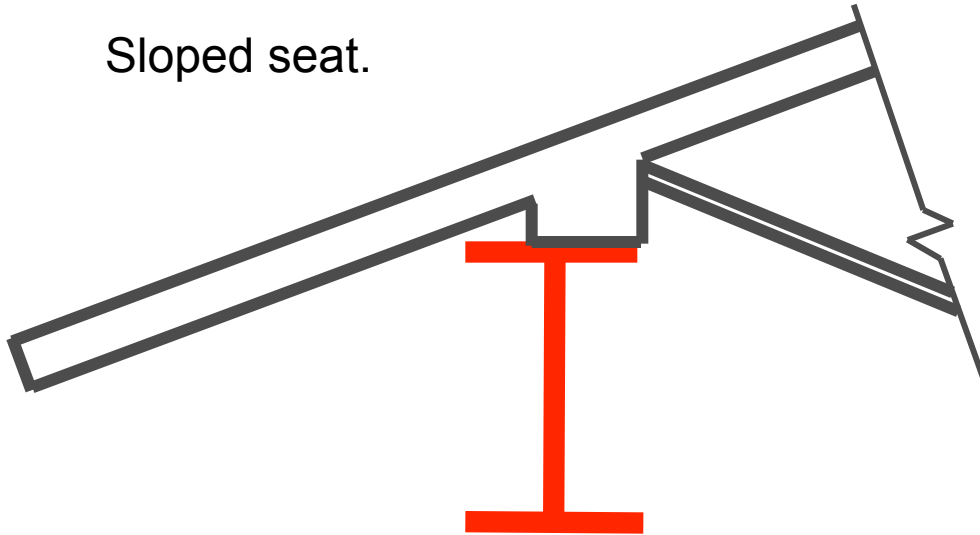

Canted Seats are problematic and extremely expensive.

Specification of Components

- K-Series and KCS Joists and other related accessories
- **LH- and DLH-Series Joists**
- Joist Girders
- Properly Specifying Steel Joists and Joist Girders



LH- and DLH-Series Joists

- LH-Series Standard Products
- DLH-Series Standard Products



LH-Series Joists

- Designations: 18LH02 to 48LH17
- Depths: 18 to 48 in.
- Standard Seat Depth (Height): 5 in. up to #17
- Span Range: 21 to 96 ft.;
- ASD Load Range: 178 to 1068 plf;
- LRFD Load Range: 267 to 1602 plf;
- Maximum Span/Depth Ratio: 24
- Types: Parallel Chord, Single Pitch, Double Pitch; Underslung or Bottom Chord Bearing



Parallel Chords, Underslung



Parallel Chords, Square Ends



Top Chord Pitched One Way, Underslung



Top Chord Pitched One Way, Square Ends



Top Chord Pitched Two Ways, Underslung



Top Chord Pitched Two Ways, Square Ends

DLH-Series Joists

- Designations: 52DLH10 to 120DLH25
- Depths: 52 to 120 in.
- Standard Seat Depth (Height): 5 in. up to #17 chords, 7.5 in. for #18 and #25 chords
- Span Range: 90 to 240 ft.
- ASD Load Range: 211 to 1304 plf;
- LRFD Load Range: 316 to 1956 plf;
- Maximum Span/Depth Ratio: 24
- Types: Parallel Chord, Single Pitch, Double Pitch; Underslung or Bottom Chord Bearing



Parallel Chords, Underslung



Parallel Chords, Square Ends



Top Chord Pitched One Way, Underslung



Top Chord Pitched One Way, Square Ends



Top Chord Pitched Two Ways, Underslung



Top Chord Pitched Two Ways, Square Ends

Specification of Components

- K-Series and KCS Joists and other related accessories
- LH- and DLH-Series Joists
- **Joist Girders**
- Properly Specifying Steel Joists and Joist Girders



Joist Girders

- Depths: 20 to 120 in.
- Standard Seat Depth (Height): 7.5 in.
- Spans: 20 to 120 ft.
- ASD Panel Point Loads: 4 to 56 kips
- LRFD Panel Point Loads: 6 to 84 kips
- Weights: 15 to 200 plf
- Various Web Configurations: G, VG, BG
- Designation: 48G8N9K; 48G8N13.5F
 - 48G is the Depth in inches
 - 8N is the Number of Joist Spaces
 - 9K is the unfactored load at each panel point
 - 13.5F is the factored load at each panel point

Joist Girders

- Joist Girder Weight Tables
- Joist Girder Configurations
- Joist Girder Standard Products

Joist Girders

- Joist Girder Weight Tables
 - Maximum chord angle size is 6 x 6 x $\frac{3}{4}$
Applicable to all joist manufacturers
- Some joist manufacturers will be able to go up to a 8 x 8 chord angle

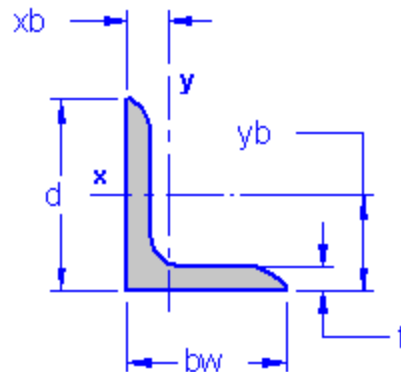

Joist Girder Weight Tables

LRFD SJI Catalog Page 164

GIRDER SPAN (ft.)	JOIST SPACES (ft.)	GIRDER DEPTH (in.)	JOIST GIRDER WEIGHT – POUNDS PER LINEAR FOOT																	
			FACTORED LOAD ON EACH PANEL POINT – KIPS																	
			6.0	9.0	12.0	15.0	18.0	21.0	24.0	27.0	30.0	36.0	42.0	48.0	54.0	60.0	66.0	72.0	78.0	84.0
35	4N@ 8.75	28	16	19	23	27	31	36	41	46	52	60	74	79	94	100	111	117	137	138
		32	15	18	21	24	28	33	37	39	45	53	60	73	80	92	100	106	112	127
		36	15	16	20	23	27	30	33	37	41	561	55	62	74	83	94	97	107	113
		40	15	16	17	21	26	27	30	37	38	46	52	61	64	75	90	95	96	108
	5N@ 7.00	28	15	20	26	32	37	43	52	57	59	73	86	100	109	126	136			
		32	15	18	24	29	34	37	45	50	53	66	75	88	100	102	112	128	138	
		36	16	17	23	27	29	35	40	46	48	62	68	77	90	100	104	115	131	133
		40	16	17	22	25	27	33	37	43	47	56	63	70	80	95	102	107	115	125
	6N@ 5.83	28	17	24	30	37	44	52	58	65	73	93	103	115	134					
		32	16	21	27	33	38	46	53	57	65	79	96	100	117	139	140			
		36	16	20	25	31	36	41	48	54	58	70	81	99	102	113	121	142	144	
		40	16	20	24	28	34	38	44	49	55	64	77	84	101	104	115	123	145	146
	7N@ 5.00	28	19	27	34	43	52	59	66	74	86	101	115	135						
		32	17	24	30	39	47	53	61	67	75	97	103	118	137					
		36	17	23	28	35	42	48	55	62	69	82	99	105	120	141	144			
		40	17	22	27	32	39	44	50	55	63	73	86	102	107	118	133	147		
	8N@ 4.38	28	21	30	39	48	59	69	78	94	98	115	136							
		32	20	27	36	42	53	61	69	79	88	101	118	138						
		36	19	26	32	39	48	55	62	71	77	99	109	121	141					
		40	18	24	30	37	44	54	60	65	73	86	102	113	127	147	149			

ASD

SJI Catalog Page 174

GIRDER SPAN (ft.)	JOIST SPACES (ft.)	GIRDER DEPTH (in.)	JOIST GIRDER WEIGHT – POUNDS PER LINEAR FOOT																	
			LOAD ON EACH PANEL POINT – KIPS																	
			4	6	8	10	12	14	16	18	20	24	28	32	36	40	44	48	52	56
35	4N@ 8.75	28	16	19	23	27	31	36	41	46	52	60	74	79	94	100	111	117	137	138
		32	15	18	21	24	28	33	37	39	45	53	60	73	80	92	100	106	112	127
		36	15	16	20	23	27	30	33	37	41	561	55	62	74	83	94	97	107	113
		40	15	16	17	21	26	27	30	37	38	46	52	61	64	75	90	95	96	108
	5N@ 7.00	28	15	20	26	32	37	43	52	57	59	73	86	100	109	126	136			
		32	15	18	24	29	34	37	45	50	53	66	75	88	100	102	112	128	138	
		36	16	17	23	27	29	35	40	46	48	62	68	77	90	100	104	115	131	133
		40	16	17	22	25	27	33	37	43	47	56	63	70	80	95	102	107	115	125
	6N@ 5.83	28	17	24	30	37	44	52	58	65	73	93	103	115	134					
		32	16	21	27	33	38	46	53	57	65	79	96	100	117	139	140			
		36	16	20	25	31	36	41	48	54	58	70	81	99	102	113	121	142	144	
		40	16	20	24	28	34	38	44	49	55	64	77	84	101	104	115	123	145	146
	7N@ 5.00	28	19	27	34	43	52	59	66	74	86	101	115	135						
		32	17	24	30	39	47	53	61	67	75	97	103	118	137					
		36	17	23	28	35	42	48	55	62	69	82	99	105	120	141	144			
		40	17	22	27	32	39	44	50	55	63	73	86	102	107	118	133	147		
	8N@ 4.38	28	21	30	39	48	59	69	78	94	98	115	136							
		32	20	27	36	42	53	61	69	79	88	101	118	138						
		36	19	26	32	39	48	55	62	71	77	99	109	121	141					
		40	18	24	30	37	44	54	60	65	73	86	102	113	127	147	149			

Joist Girders

Joist Girder Weight Tables

- The weight table can not cover every combination of span, panel spacing and kip loading
- A Joist Girder can be made to fit within any of the “gaps” in the weight table
- Remember that the weight table is a design aid for the structural engineer to help provide an approximate value for the Joist Girder self weight

Joist Girder Web Configurations

For $D/S < 0.36$

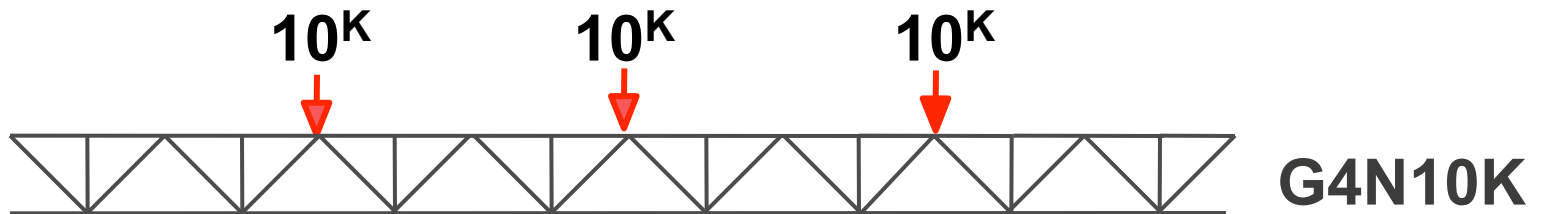

For $0.36 < D/S < 0.70$

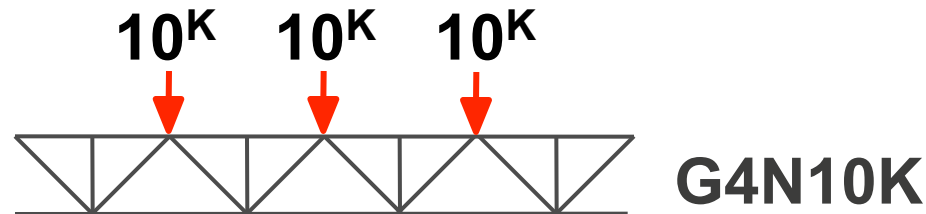

Joist Girder Web Configurations

For $D/S > 0.70$

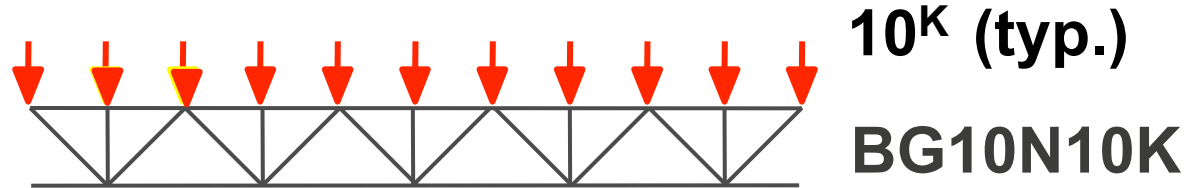

For $D/S < 0.70$ only

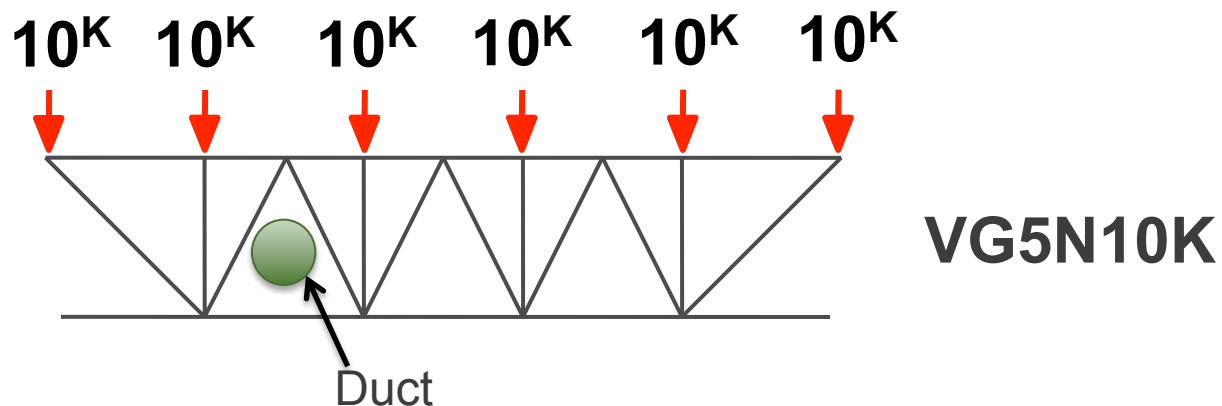

Specification of Components

- K-Series and KCS Joists
- LH- and DLH-Series Joists
- Joist Girders
- **Properly Specifying Steel Joists and Joist Girders**



Joists Subjected to Uniform Loads

- SJI Load Tables
 - D SPEC #
 - 28K8
 - 28K328/**222** ASD Uniform Load at 40'
 - 28K492/**222** LRFD Uniform Load at 40'
 - **222** plf will produce a deflection of L / 360
- Economical Joist Guide

Loads noted in **red** are only presented so that the specifier can consider deflection in his selections. They are not used in the joist design. Actual live loads must be specified if load cases other than simple span uniform load are to be considered, such as end moments, axial loads, etc.

ASD

STANDARD LOAD TABLE FOR OPEN WEB STEEL JOISTS, K-SERIES
Based on a 50 ksi Maximum Yield Strength - Loads Shown In Pounds Per Linear Foot (plf)

Joist Designation	24K4	24K5	24K6	24K7	24K8	24K9	24K10	24K12	26K5	26K6	26K7	26K8	26K9	26K10	26K12
Depth (In.)	24	24	24	24	24	24	24	24	26	26	26	26	26	26	26
Approx. Wt. (lbs./ft.)	7.8	7.9	8.5	9.0	9.4	10.3	11.7	13.5	8.1	8.6	9.0	9.7	10.4	11.8	13.7
Span (ft.)															
↓															
23	550	550	550	550	550	550	550	550							
	550	550	550	550	550	550	550	550							
24	520	550	550	550	550	550	550	550							
	516	544	544	544	544	544	544	544							
25	479	540	550	550	550	550	550	550	550	550	550	550	550	550	550
	456	511	520	520	520	520	520	520	550	550	550	550	550	550	550
26	442	499	543	550	550	550	550	550	542	550	550	550	550	550	550
	405	453	493	499	499	499	499	499	535	541	541	541	541	541	541
27	410	462	503	550	550	550	550	550	502	547	550	550	550	550	550
	361	404	439	479	479	479	479	479	477	519	522	522	522	522	522
28	381	429	467	521	550	550	550	550	466	508	550	550	550	550	550
	323	362	393	436	456	456	456	456	427	464	501	501	501	501	501
29	354	400	435	485	536	550	550	550	434	473	527	550	550	550	550
	290	325	354	392	429	436	436	436	384	417	463	479	479	479	479

Standard Joist Loading

- Chord Design:



$$M_{\max} = \frac{wL^2}{8}$$

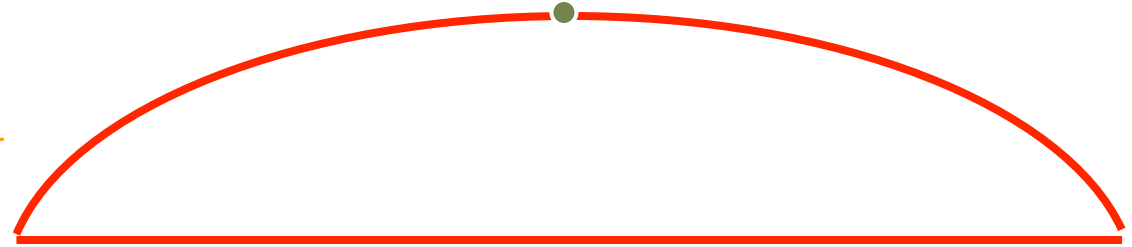

- Web Design:



$$V_{\max} = \frac{wL}{2}$$

$$V_{\min} = \frac{wL}{8}$$

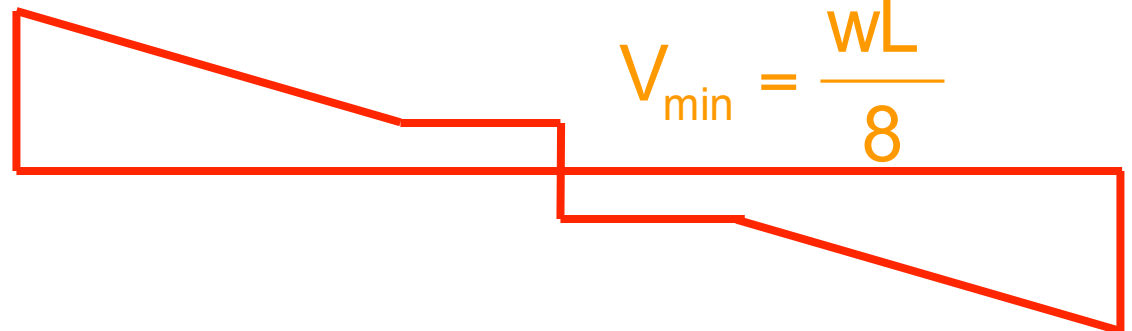

Note: Web configurations shown are for information only; it is not intended to describe the layout to be used for the actual joist design.

Definition of Span

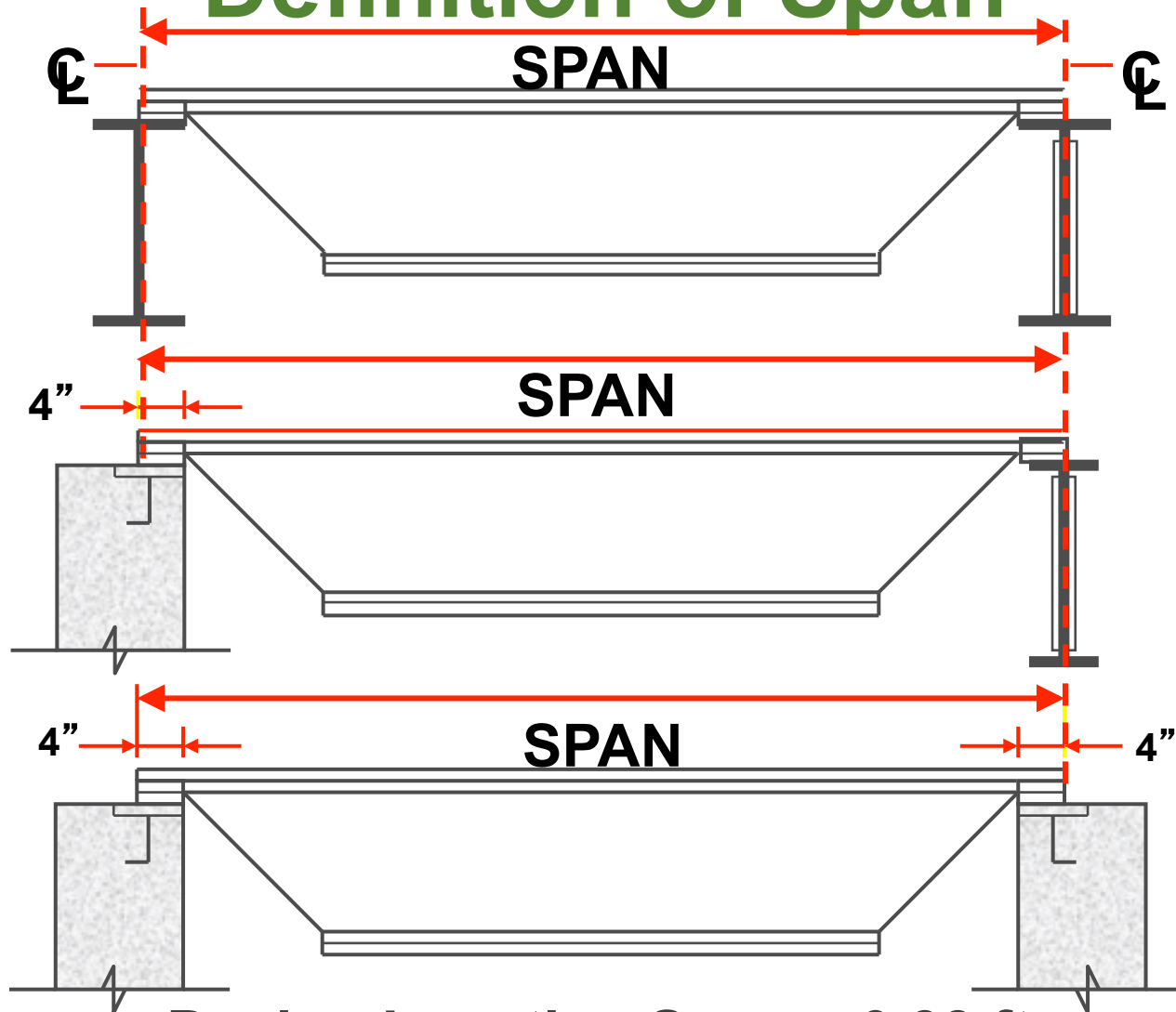

Properly Specifying Steel Joists and Joist Girders

- Joist Load Diagrams
- Joist and Joist Girder Schedules
- Joist Girder Load Diagrams



Joist Load Diagram

Uniformly Distributed and Concentrated Loads

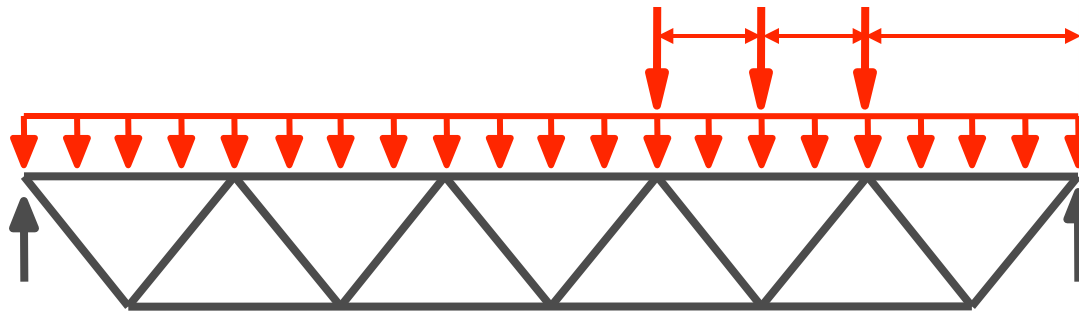

Open-Web Steel Joists, Round Bar Webs

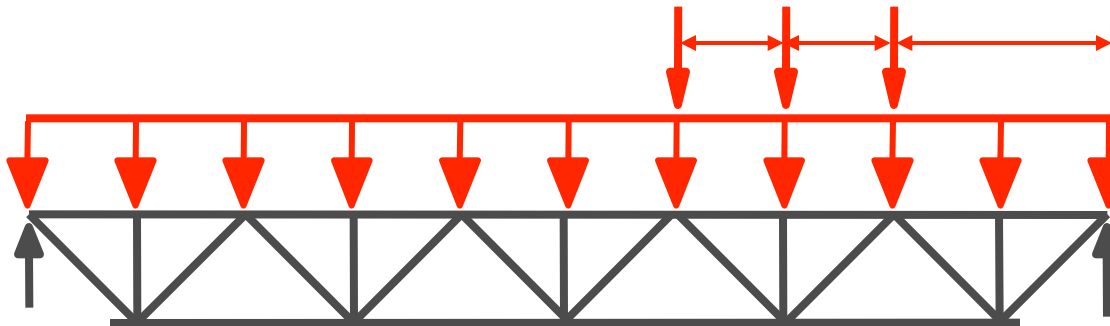

Open-web Steel Joists, Crimped Angle Webs; Longspan Steel Joists, Crimped, Single, or Double-angle Webs

Note: Web configurations shown are for information only; it is not intended to describe the layout to be used for the actual joist design.

Joist Load Diagram

UDL Dead Load $w_D = 100$ plf

UDL Live Load $w_L = 150$ plf

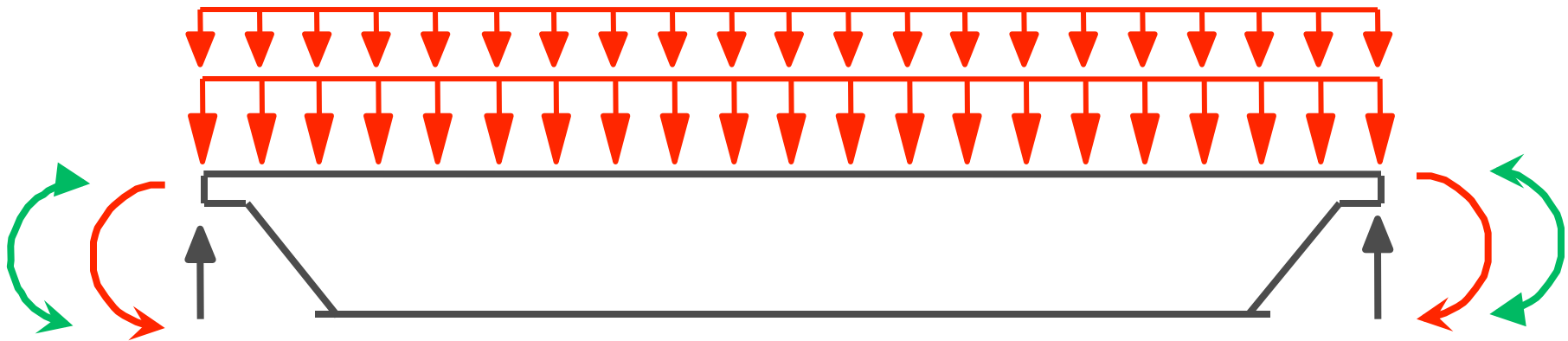

Live Load Moments

$$M_L = 50 \text{ ft.-kips}$$

Wind and or Seismic Moments

$$M_w = \pm 26.67 \text{ ft.-kips (Both Ends)}$$

Joist Girder Schedule

Controlling Load Combinations for Joist Girder

Mark: G1	Girder Designation: _G_N SP					
LRFD Load Combination:	Panel Load (kips)	Left End Moment (kip-ft.)	Right End Moment (kip-ft.)	TC Force (kips)	BC Force (kips)	Remarks
$1.2(D+C) + 1.6L_r (L-R)^*$						
$1.2(D+C) + 1.6L_r (R-L)^*$						
$1.2(D+C) + 1.6L_r + 0.8W (L-R)$						
$1.2(D+C) + 1.6L_r + 0.8W (R-L)$						
$1.2(D+C) + 1.6W (L-R) + 0.5L_r$						
$1.2(D+C) + 1.6W (R-L) + 0.5L_r$						
$0.9D + 1.6W (L-R)$						
$0.9D + 1.6W (R-L)$						
$(1.2 + 0.2S_{DS}) (D+C) + \rho Q_E + 0.2S (L-R)$						
$(1.2 + 0.2S_{DS}) (D+C) + \rho Q_E + 0.2S (R-L)$						
$(0.9 - 0.2S_{DS})D + \rho Q_E (L-R)$						
$(0.9 - 0.2S_{DS})D + \rho Q_E (R-L)$						
Column M_p , (AISC OMF Criteria)						
Column M_p , (AISC OMF Criteria)						

- * The first two load combinations look identical; however, they are different in that the notional loads, per the Direct Analysis Method in the 2005 AISC Specification, must be applied in opposite directions.

Joist Girder Load Diagram

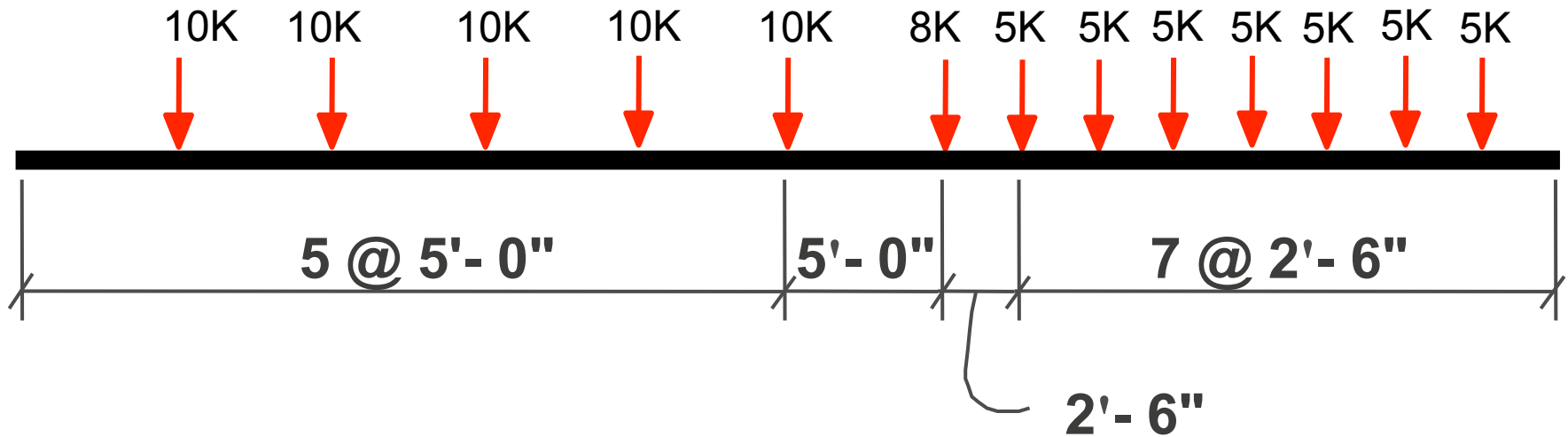

48G14NSP

Joist Manufacturer to include self weight for joist girder SP

Self Weight of Joists and Joist Girders

- When specifying joists, always include the self weight of joists and bridging.
- When specifying Joist Girders, it is expected that the self weight of the girders is included in the specified kip designation. When this is not the case, the design drawings must clearly note that self weight is not included and the manufacturer must add self weight.

Never assume the joist manufacturer knows what to design the joist for.



National Codes and Standards

- Building Codes
 - International Building Code (IBC)
 - NFPA 5000 Building Code
 - Specialized, State or Local Jurisdiction Codes, FBC (FL), CBC (CA), etc.
- ASCE/SEI 7-10 Minimum Design Loads for Buildings and Other Structures
- The interpretation of Building Codes is the responsibility of the Specifying Professional

International Building Codes

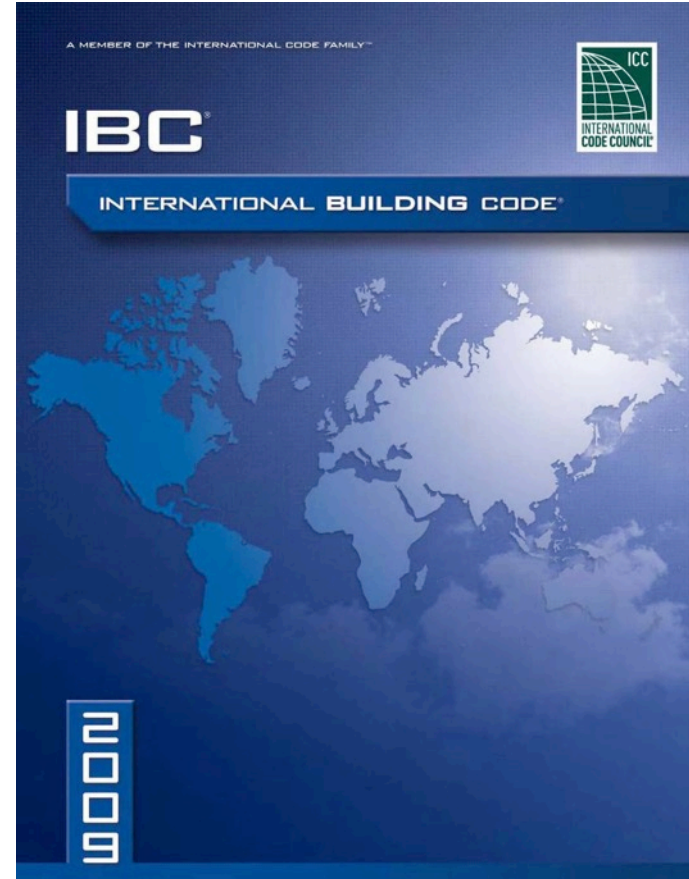
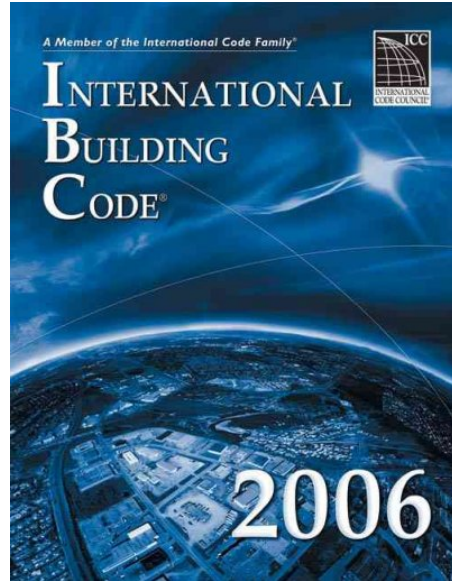

**Code Publication Date
vs State Adoption**

IBC Section 2207, Steel Joists

- The IBC is very specific about the responsibilities of the Registered Design Professional and the responsibilities of the Steel Joist Manufacturer.
- The Registered Design Professional is the Engineer of Record and not the Steel Joist Manufacturer's engineer.

IBC Section 2207, Steel Joists

2207.1 General. The design, manufacture and use of open web steel joists and joist girders shall be in accordance with one of the following Steel Joist Institute (SJI) specifications:

1. **SJI CJ**
2. **SJI K**
3. **SJI LH/DLH**
4. **SJI JG**

2207.1.1 Where required, the seismic design of buildings shall be in accordance with the additional provisions of Section 2205.2 or 2210.5.

IBC Section 2207, Steel Joists

2207.2 Design. The registered design professional shall indicate on the construction documents the steel joist and/or steel joist girder designations from the specifications listed in Section 2207.1 and shall indicate the requirements for joist and joist girder design, layout, end supports, anchorage, non-SJI standard bridging, bridging termination connections and bearing connection design to resist uplift and lateral loads. These documents shall indicate special requirements as follows:

1. Special loads including:
 - 1.1. Concentrated loads;
 - 1.2. Nonuniform loads;
 - 1.3. Net uplift loads;
 - 1.4. Axial loads;
 - 1.5. End moments; and
 - 1.6. Connection forces.

IBC Section 2207, Steel Joists

All loads must be specified on the structural drawings.

Referencing loads on the M or FP drawings or noting loads to be coordinated by GC are problematic to properly bid the project.

All brace loads must be specified with a magnitude, otherwise they will be assumed to be included in the uniform joist designation.

Mech units should be attached to a frame and not directly to the joist chords.

IBC Section 2207, Steel Joists

2207.2 Design.

2. Special considerations including:
 - 2.1. Profiles for nonstandard joist and joist girder configurations (standard joist and joist girder configurations are as indicated in the SJI catalog);
 - 2.2. Oversized or other nonstandard web openings; and
 - 2.3. Extended ends.
3. Deflection criteria for live and total loads for non-SJI standard joists.



IBC Section 2207, Steel Joists

All deflection requirements must be noted on the structural drawings.

IBC 2015 Section 2207, Steel Joists

2207.3 Calculations. The steel joist and joist girder manufacturer shall design the steel joists and/or steel joist girders in accordance with the current SJI specifications and load tables to support the load requirements of Section 2206.2. The registered design professional may require submission of the steel joist and joist girder calculations as prepared by a registered design professional responsible for the product design. If requested by the registered design professional, the steel joist manufacturer shall submit design calculations with a cover letter bearing the seal and signature of the joist manufacturer's registered design professional. In addition to standard calculations under this seal and signature, submittal of the following shall be included:

1. Non-SJI standard bridging details (e.g. for cantilevered conditions, net uplift, etc.).
2. Connection details for:
 - 2.1. Non-SJI standard connections (e.g. flush-framed or framed connections);
 - 2.2. Field splices; and
 - 2.3. Joist headers.

Joist Submittal Types

Approval

- Submitted with the joist placement plans, for approval

Deferred

- Submitted after EOR approval of joist placement plans, but before delivery

Record

- Submitted after delivery, as a record set

IBC Section 2207, Steel Joists

2207.4 Steel joist drawings. Steel joist placement plans shall be provided to show the steel joist products as specified on the construction documents and are to be utilized for field installation in accordance with specific project requirements as stated in Section 2206.2. Steel placement plans shall include, at a minimum, the following:

1. Listing of all applicable loads as stated in Section 2206.2 and used in the design of the steel joists and joist girders as specified in the construction documents.
2. Profiles for nonstandard joist and joist girder configurations (standard joist and joist girder configurations are as indicated in the SJI catalog).

IBC Section 2207, Steel Joists

2207.4 Steel joist drawings.

3. Connection requirements for:
 - 3.1. Joist supports;
 - 3.2. Joist girder supports;
 - 3.3. Field splices; and
 - 3.4. Bridging attachments.
4. Deflection criteria for live and total loads for non-SJI standard joists.
5. Size, location and connections for all bridging.
6. Joist headers.

Steel joist placement plans do not require the seal and signature of the joist manufacturer's registered design professional.

IBC Section 2207, Steel Joists

2207.5 Certification. At completion of fabrication, the steel joist manufacturer shall submit a certificate of compliance as specified with Section 1704.5 stating that work was performed in accordance with approved construction documents and with SJI standard specifications listed in Section 2207.1.

Basic Load Combinations

- IBC 1605.2.1 Load and Resistance Factor Design

Basic load combinations. Where strength or load resistance factor design is used, structures and portions thereof shall resist the most critical effects resulting from the following combinations of factored loads:

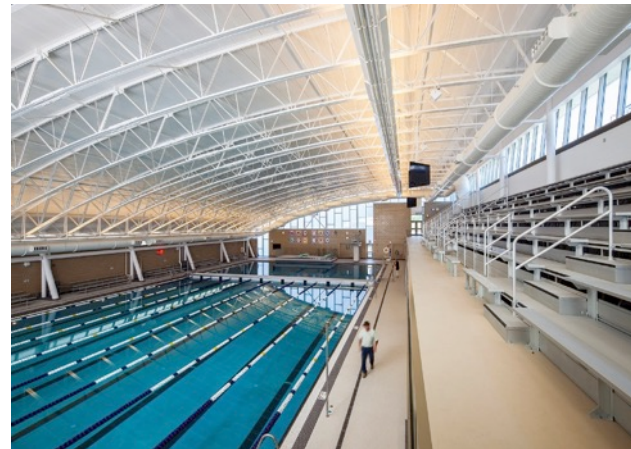

2015 IBC Section 1605, Load Combinations

1605.2 Load combinations using strength design or load and resistance factor design.

1605.2 Basic load combinations

$$1.4(D+F) \quad (\text{Eqn 16-1})$$

$$1.2(D+F) + 1.6(L+H) + 0.5(L_r \text{ or } S \text{ or } R) \quad (\text{Eqn 16-2})$$

$$1.2(D+F) + 1.6(L_r \text{ or } S \text{ or } R) + 1.6H + (f_1L \text{ or } 0.5W) \quad (\text{Eqn 16-3})$$

$$1.2(D+F) + 1.0W + f_1L + 1.6H + 0.5(L_r \text{ or } S \text{ or } R) \quad (\text{Eqn 16-4})$$

$$1.2(D+F) + 1.0E + f_1L + 1.6H + f_2S \quad (\text{Eqn 16-5})$$

$$0.9D + 1.0W + 1.6H \quad (\text{Eqn 16-6})$$

$$0.9(D+F) + 1.0E + 1.6H \quad (\text{Eqn 16-7})$$

IBC Section 1605, Load Combinations

When specifying loads, using the LRFD design method, it must be clearly stated whether the shown loads have been factored.

Generally, the total uniform load as determined from equation 16-2, 16-3 and 16-4 is shown as factored.

If additional load cases are required to be evaluated all loads must be classified (wind, snow, etc.) and provided as unfactored.

Basic Load Combinations

f_1 = 1.0 for floors in places of public assembly, for live loads in excess of 100 psf and for parking garage live load, and

= 0.5 for other live loads

f_2 = 0.7 for roof configurations (such as saw tooth) that do not shed snow off the structure, and

= 0.2 for other roof configurations

Exception: Where other factored load combinations are specifically required by the provisions of this code, such combinations shall take precedence.

Basic Load Combinations

- IBC 1605.3.1 Allowable Stress Design

Basic load combinations. Where allowable stress design (working stress design), as permitted by this code, is used, structures and portions thereof shall resist the most critical effects resulting from the following combinations of loads:

2015 IBC Section 1605, Load Combinations

1605.3 Load combinations using allowable stress design.

$$D + F \quad \text{(Eqn 16-8)}$$

$$D + H + F + L \quad \text{(Eqn 16-9)}$$

$$D + H + F + (Lr \text{ or } S \text{ or } R) \quad \text{(Eqn 16-10)}$$

$$D + H + F + 0.75L + 0.75(Lr \text{ or } S \text{ or } R) \quad \text{(Eqn 16-11)}$$

$$D + H + F + (0.6W \text{ or } 0.7E) \quad \text{(Eqn 16-12)}$$

$$D + H + F + 0.75(0.6W) + 0.75L + 0.75(Lr \text{ or } S \text{ or } R) \quad \text{(Eqn 16-13)}$$

$$D + H + F + 0.75(0.7E) + 0.75L + 0.75S \quad \text{(Eqn 16-14)}$$

$$0.6D + 0.6W + H \quad \text{(Eqn 16-15)}$$

$$0.6(D + F) + 0.7E + H \quad \text{(Eqn 16-16)}$$

IBC Section 1605, Load Combinations

- When specifying loads it must be clearly stated what the shown loads are.
- Generally, the total uniform load as determined from equation 16-9, 16-10 and 16-11 is shown.
- If additional load cases are required to be evaluated all loads must be classified and provided unfactored including E.

Basic Load Combinations

- IBC 2605.3.2 Alternate Basic Load Combinations

In lieu of the basic load combinations specified in Section 1605.3.1, structures and portions thereof shall be permitted to be designed for the most critical effects resulting from the following combinations.

When using these alternate basic load combinations that include wind or seismic loads, allowable stresses are permitted to be increased or load combinations reduced, where permitted by the material section of this code or referenced standard. Where wind loads are calculated in accordance with Section 1609.6 or ASCE 7, the coefficient ω in the following formulas shall be taken as 1.3. For other wind loads ω shall be taken as 1.0.

Alternate Basic Load Combinations

$$D + L + (L_r \text{ or } S \text{ or } R) \quad (\text{Eqn 16-17})$$

$$D + L + (\omega W) \quad (\text{Eqn 16-18})$$

$$D + L + \omega W + S / 2 \quad (\text{Eqn 16-19})$$

$$D + L + S + \omega W / 2 \quad (\text{Eqn 16-20})$$

$$D + L + S + E / 1.4 \quad (\text{Eqn 16-21})$$

$$0.9D + E / 1.4 \quad (\text{Eqn 16-22})$$

The same expectations apply to these Alternate Basic Load Combinations as apply to the Basic Load Combinations using allowable stress design.

ASCE/SEI 7-16 Standard

Minimum Design Loads for Buildings and other Structures

- 2 Combinations of Loads
- 3 Dead Loads, Soil Loads, and Hydrostatic Pressure
- 4 Live Loads
- 7 Snow Loads
- 8 Rain Loads
- 10 Ice Loads
- 12** Seismic Design Requirements for Building Structures
- 26, 27, 28, 29, 30 Wind Loads

Chapter 2: Combinations of Loads

- Buildings and other structures shall be designed using the provisions of either Section 2.3 or 2.4. Either Section 2.3 or 2.4 shall be used exclusively for proportioning elements of a particular construction material throughout the structure.

2.3 LOAD COMBINATIONS FOR STRENGTH DESIGN

2.4 LOAD COMBINATIONS FOR ALLOWABLE STRESS DESIGN

The basic combinations in each of these sections are the same as those found in the IBC Code.

Chapter 3: Dead Loads

Self Weight of Joists and Joist Girders

- When specifying joists, always include the self weight of joists and bridging.
- When specifying Joist Girders, it is normal that the self weight of the girders is included in the specified loads. When this is not the case, the design drawings must clearly note that self weight is not included and the manufacturer must add self weight.

Chapter 6: Wind Loads

- When wind uplift is a design consideration, it should be specified as net uplift on the joists and Joist Girders.
- The Specifying Professional knows the design dead load and if there are collateral dead loads that should not be deducted from the gross uplift.
- Joists are considered components and cladding.
- The joist tributary width need not be less than one-third the joist span.

Chapter 26, 27, 28, 29, 30: Wind Loads

- Joist Girders can be considered part of the main wind force-resisting system (MWFRS), although it is common to simply apply the joist uplift end reactions.
- Joist Girder tension webs must be designed to resist, in compression, 25 percent of their axial force.
- Hence, uplift loads on a Joist Girder of less than 25 percent of the gravity loads have minimal or no effect on the girder design.

Wind Loads: Net Uplift

A typical zone uplift diagram



Be sure to dimension the width of the zones.

Chapter 7: Snow Loads

- The Specifying Professional may need to consider unbalanced roof snow load conditions for:
 - Hip and Gable Roofs
 - Curved Roofs
 - Multiple Folded Plate, Sawtooth and Barrel Vault Roofs
 - Dome Roofs

- The Specifying Professional may also need to consider the cases of Partial Loading, Drifts on Lower Roofs, Roof Projections, Sliding Snow, Rain-on-Snow Surcharge Load and Ponding Instability.

- If joist are to be designed for of these loads it must be noted on the contract drawings.



Chapter 12: Seismic Load Effects

- Section 12.4.1 Applicability.

All members of the structure, including those not part of the seismic force-resisting system, shall be designed using the seismic load effects of Section 12.4 unless otherwise exempted by this standard. Seismic load effects are the axial, shear, and flexural member forces resulting from application of horizontal and vertical seismic forces as set forth in Section 12.4.2. Where specifically required, seismic load effects shall be modified to account for system overstrength, as set forth in Section 12.4.3.

Loads

The Steel Joist Institute does not presume to establish the loading requirements for which structures are designed.

The Steel Joist Institute Load Tables are based on uniform loading conditions and are valid for use in selecting joist sizes for gravity loads that can be expressed in terms of "pounds per linear foot" (kiloNewtons per Meter) of joist. The Steel Joist Institute Joist Girder Weight Tables are based on uniformly spaced panel point loading conditions and are valid for use in selecting Joist Girder sizes for gravity conditions that can be expressed in kips (kiloNewtons) per panel point on the Joist Girder.

The Specifying Professional shall provide the nominal loads and load combinations as stipulated by the applicable code under which the structure is designed and shall provide the design basis (ASD or LRFD).

Concentrated Loads

Where concentrated loads occur, the magnitude and location of these concentrated loads shall be shown on the structural drawings when, in the opinion of the Specifying Professional, they may require consideration by the joist manufacturer.

The Specifying Professional shall use one of the following options that allows the:

- Estimator to price the joists.
- Joist manufacturer to design the joists properly.
- Owner to obtain the most economical joists.

OPTION 1: Select a Standard SJI joist for the UDL and provide the load and location of any additional loads.

OPTION 2: Select a KCS joist using moment and end reaction.

OPTION 3: Specify a SPECIAL joist with load diagrams.

Concentrated Loads

LRFD Load Diagram per ASCE 7 2.3.2 (3): $1.2D + 1.6S$

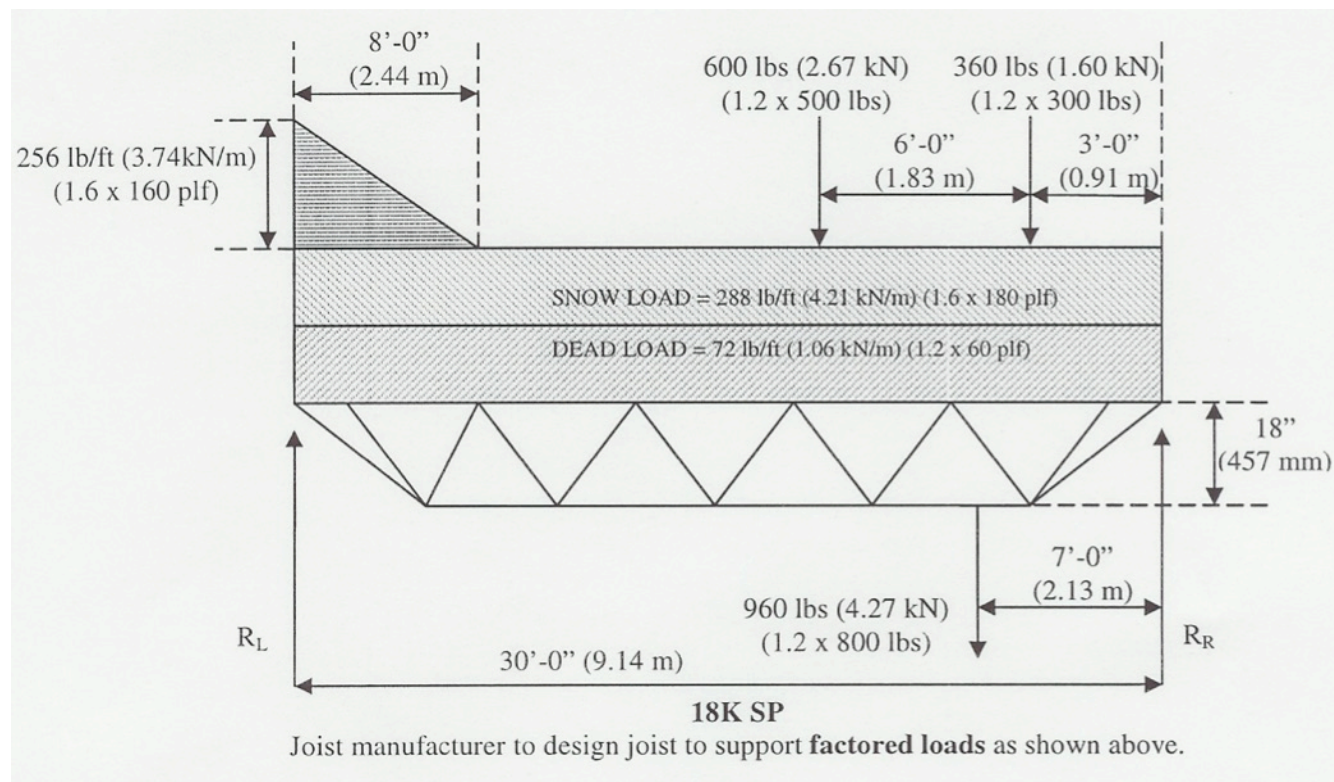

Concentrated Loads

ASD Load Diagram per ASCE 7 2.4.1 (3): D + S

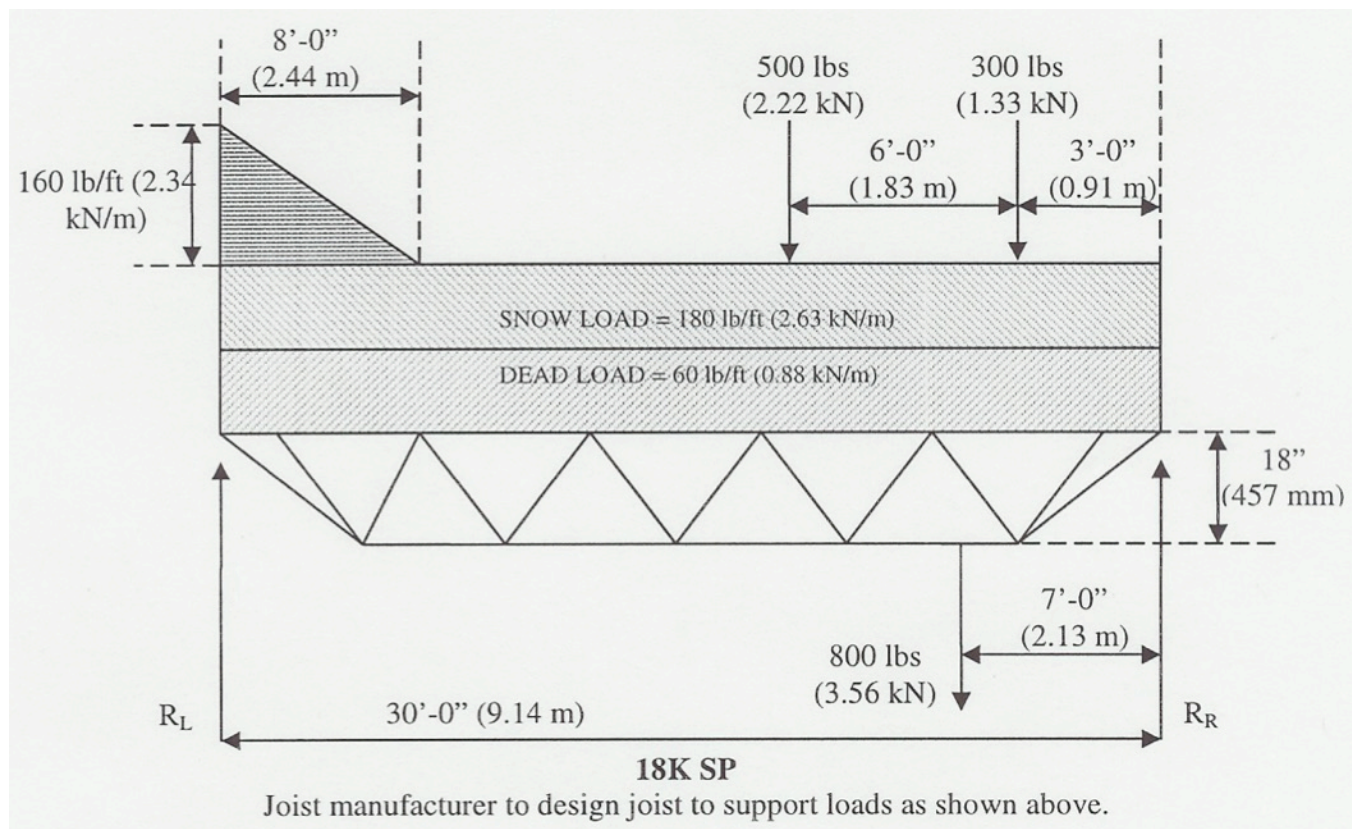

Concentrated Loads

The load combinations previously shown are for the referenced examples only.

It is not to be presumed that the joist designer is responsible for any load combinations other than those noted in the applicable building code unless specifically noted on the structural drawings. The EOR should consider load cases that include positive wind loads when selecting the joist designation.

If the loading criteria are too complex to adequately communicate in a simple load diagram, then the specifying professional shall provide a load schedule showing the specified design loads, load categories, and required load combinations with applicable load factors (i.e. for ASD or LRFD).

Concentrated Loads

Concentrated loads from braces, HVAC or other trades need to be identified and the loads specified by the EOR on the contract drawings.

This allows for the project to be quoted correctly and for the approval drawings to be complete without RFI's.

If concentrated loads are included in the standard uniform loads or included in the standard SJI joist designation, that should be noted on the drawings.

If braces or other connections are to be made to the bottom chord of the joist it must be noted and in some cases additional bottom chord bracing will be needed.

Specifying Loads

from SJI Code of Standard Practice Section 2.4(a), 44th Edition Catalog

Option 3: For additional point loads with exact locations not known along the joist or for incidental loads, any one, or both, of the following can be specified on the structural plan in addition to option 1 or 2 above:

- a) "Design for a () lb. concentrated load located at any one panel point along the joist". This is referred to as an "Add-Load". ←
- b) "Design for additional bending stresses resulting from a () lb. concentrated load located at any location along () chord". This is referred to as a "Bend-Check" and can be specified on top chord, bottom chord, or both top and bottom chords. This can be used when the concentrated load is already accounted for in the joist designation, uniform load, or specified Add-Load yet this specified amount of load shall be permitted to also be located at any location between panel points. The additional bending stresses as a result of this load are then designed for. A Bend-Check load shall not exceed (Add-Load + 400 lbs.) A Bend-Check load can be specified by itself without an Add-Load.
- c) Both (a) and (b) above can be specified with equal concentrated loads for each; or simply denote "Design joist for a () lb. concentrated load at any location along the () chord."

Deflection

Joist deflection must be specified by the EOR on the contract drawings.

In general deflection requirements are taken from 2016 IBC table 1604.3.

Typically unless specified joists are not design for a total load deflection in accordance with table 1604.3.

Joist Primer

The primer applied to the joist is a provisional coating, and should not be considered as the final coating.

This primer is generally applied by dipping the joist in a large tank. Consequently the coating will have some inconsistencies in thickness and surface conditions.

Structural Design Process

1. Determine bay size
2. Determine clear height, eave height, story height
3. Determine roof and floor system
 - a. Roofing type
 - b. Composite, non-composite
 - c. Fire proofing
 - d. Drainage
 - e. Loads
4. Determine lateral load system and associated loads
5. Determine serviceability criteria
6. Determine structural system depth

Structural Design Process

6. Determine direction of framing
7. Select joists and Joist Girders
8. Select deck type
9. Determine spandrel system and loads
10. Design edge plate and supports
11. Determine loading on building edges
 - a. Joist extensions
 - b. Seat depths
 - c. Outriggers
12. Design roof and floor diaphragms

Steps for a Typical Joist Project

- Goals:
 - Provide the Correct Joists per EOR and Architect's drawings and specifications.



Manufacturer's Typical Process

1. Engineer specifies the joists and Joist Girders
2. Joist manufacturer receives the plans
3. Joist manufacturer prepares the estimate
4. Joist manufacturer submits bid
5. After receiving the award
 - a. Prepares joist placement plans and lists
6. Joist manufacturer submits plans for approval
7. Owner / Customer and Engineer / Architect reviews and approves plans
 - a. Joist manufacturer prepares final joist design

Manufacturer's Typical Process

8. Joist manufacturer obtains materials, prepares shop orders, and schedules:
 - a. Production time
 - b. Shipping
9. Joist manufacturer manufactures the joists and accessories and performs QC
10. Joist manufacturer ships joists
11. The erector receives the joists at the site and checks the bill of lading and removes the joists from the trucks
12. The erector erects the joists

Building Information Technology

The Steel Joist Institute and its members support BIM technology and encourage the use of this technology in current construction practice.

The development of steel joist three dimensional models to be used in the construction model for coordination with other trades and allows the builder to recognize potential field issues before the joist are manufactured and delivered.



The SJI BIM Guidance initiative continues to evolve as the construction industry evolves.

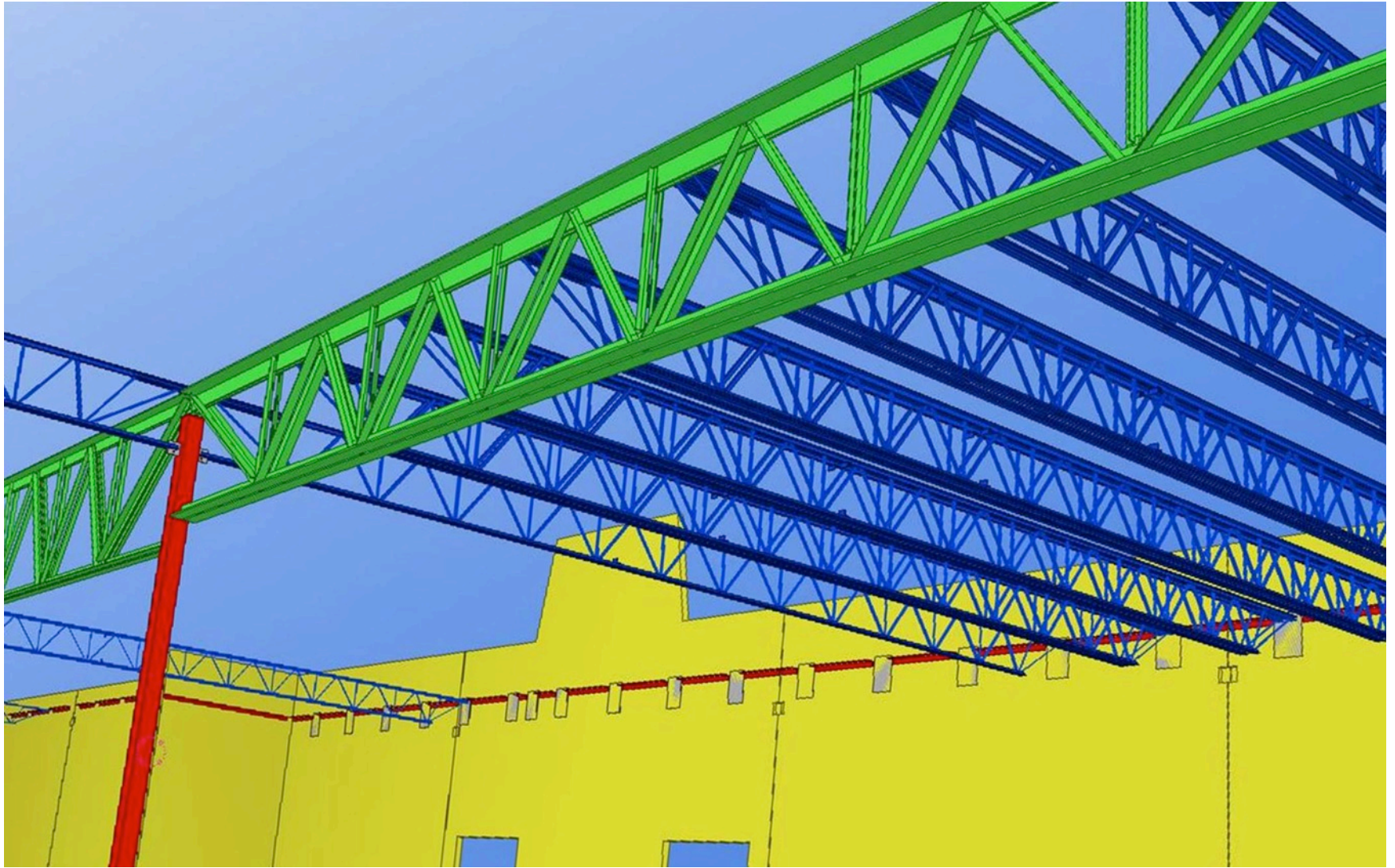



Red Dot indicates where a steel joist plant is located

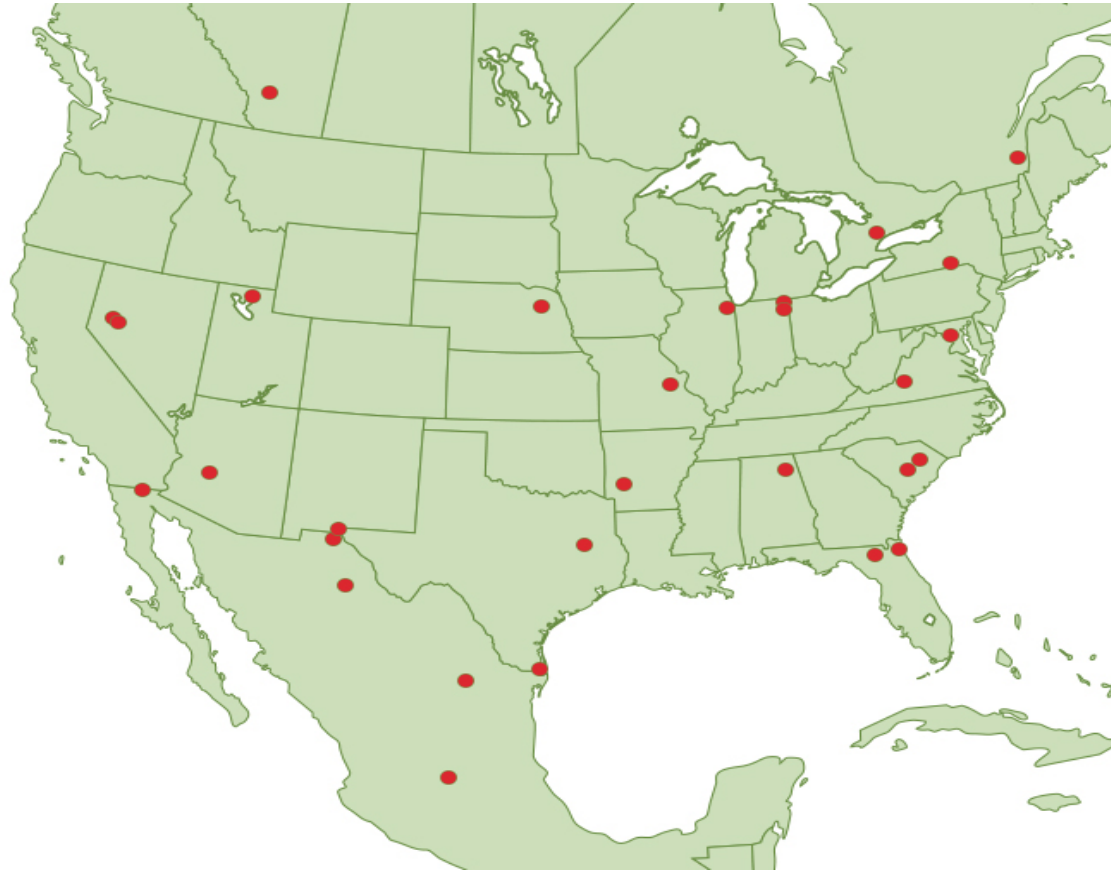

Polling Question 2

Please complete the following sentence:

When specifying loads for joist, there is/are _____ way /
ways to do so.

- A. one
- B. two
- C. several depending on the circumstance,



THANK YOU

Copyright © 2018 Steel Joist Institute. All Rights Reserved.